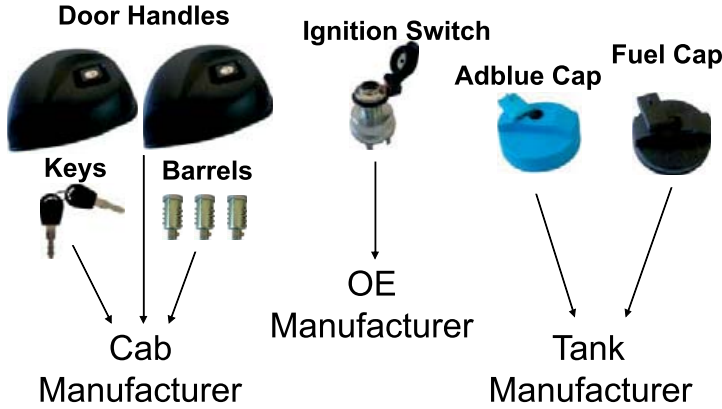

KİLİT SETLERİ

LOCK SETS

SCHLOSS - SÄTZE

**NESAN®**

- Door handles, keys and barrels are sent to cab manufacturer
- Fuel and adblue caps are sent to fuel tank manufacturer
- Ignition switch is sent to OE manufacturer

Cab Manufacturer:



Cab manufacturer receives the products above in a nylon bag. a) Assembles the door handles to vehicle. b) Hangs the nylon bag, (including the 3 barrels and 2 keys) into the cab.

Fuel Tank Manufacturer:



Fuel tank manufacturer receives the products above without the barrels inside.

OE Manufacturer:



OE manufacturer receives the ignition switch without barrel and assembles it to the vehicle.

NS 2002
BMC - FATİH (8R204749)

SET İÇİNDEKİLER

NS 105 00 KONTAK ANAHTARI
NS 839 04 DEPO KAPAĞI
NS 950 00 KAPI KOLU

(PAGE)
SAYFA
1 ad. 20
1 ad. 55
2 ad. 64

NS 2004
BMC PRO Y.M.
(58RS502924 - 58RS017246)

SET İÇİNDEKİLER

NS 141 00 KONTAK ANAHTARI
NS 839 04 DEPO KAPAĞI
NS 902 00 KAPI KİLİDİ (R)
NS 902 01 KAPI KİLİDİ (L)

(PAGE)
SAYFA
1 ad. 26
1 ad. 55
1 ad. 61
1 ad. 61

NS 2044
BMC LEVEDN 3.0 - FC MDS - MDT
(58RS502910)

SET İÇİNDEKİLER

NS 140 00 KONTAK ANAHTARI
NS 845 01 DEPO KAPAĞI
NS 902 00 KAPI KİLİDİ (R)
NS 902 01 KAPI KİLİDİ (L)

(PAGE)
SAYFA
1 ad. 26
1 ad. 55
1 ad. 61
1 ad. 61

NS 2066
BMC MEGASTAR TEK SIRA KAMYONET
(58RS113197)

SET İÇİNDEKİLER

NS 140 00 KONTAK ANAHTARI
NS 845 01 DEPO KAPAĞI
NS 829 01 STEPNE KİLİDİ
NS 913 00 KAPI KİLİDİ (R)
NS 913 01 KAPI KİLİDİ (L)

(PAGE)
SAYFA
1 ad. 26
1 ad. 55
1 ad. 53
1 ad. 62
1 ad. 62

NS 2069
BMC LEVEND 2.5 - 3.0 E.M.
(58RS100793)

SET İÇİNDEKİLER

NS 115 00 KONTAK ANAHTARI
NS 961 00 KAPI KOLU

(PAGE)
SAYFA
1 ad. 26
1 ad. 65

NS 2119
FORD CARGO
(6C46 - 3688-AA)

SET İÇİNDEKİLER

NS 142 01 KONTAK ANAHTARI
NS 843 05 DEPO KAPAĞI
NS 915 00 KAPI KİLİDİ (R)
NS 915 01 KAPI KİLİDİ (L)

(PAGE)
SAYFA
1 ad. 26
1 ad. 55
1 ad. 62
1 ad. 62

NS 2144
KARSAN

SET İÇİNDEKİLER

NS 144 00 KONTAK ANAHTARI
NS 826 00 DEPO KAPAĞI
NS 936 01 ARKA BAGAJ KİLİT GÖBEĞİ
NS 937 00 SERVİS KAPISI KİLİT GÖBEĞİ FİŞEĞİ
NS 949 00 KAPI KİLİDİ (R)
NS 949 01 KAPI KİLİDİ (L)

(PAGE)
SAYFA
1 ad. 26
1 ad. 53
1 ad.
1 ad.
1 ad. 64
1 ad. 64

Ns 2146
FORD OTOSAN
(AC46-3688-DA)

SET İÇİNDEKİLER

NS 142 00 KONTAK ANAHTARI
NS 843 04 DEPO KAPAĞI
NS 837 10 ADBLUE KAPAĞI
NS 845 03 SERVİS KAPISI KİLİT GÖBEĞİ FİŞEĞİ
NS 915 02 KAPI KİLİDİ (R)
NS 915 03 KAPI KİLİDİ (L)

(PAGE)
SAYFA
1 ad. 26
1 ad. 55
1 ad. 54
1 ad. 55
1 ad. 62
1 ad. 62

UZAKTAN KUMANDA ve IMMOBILIZER SİSTEMİ

REMOTE KEYLESS ENTRY & IMMOBILIZER SYSTEMS

SCHLÜSSELLOSE FERNBEDIENUNG & WEGFAHRSPERRE SYSTEME



NESAN®



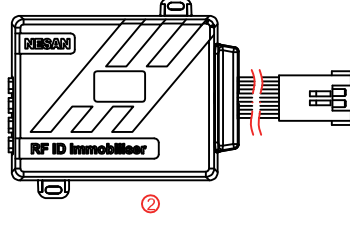

IMMOBİLİZER SETİ

| | | | | |
|------|--------------------------------|---------------|-----------|--------------------|
| 1 | ANTEN KABLAJ TAKIMI | NE 4007 00 | 5 | |
| 1 | UYARI LEDİ | NE 4006 00 | 4 | |
| 1 | ANTEN | NE 4001 24 04 | 3 | |
| 1 | RF ID IMMOBİLİZER MODUL TAKIMI | NE 4001 24 | 2 | 24 V |
| 2 | UZAKTAN KUMANDA ANAHTARI | NE 4003 00 | 1 | ŞİFRESİZ ANAHTARLI |
| ADET | PARÇA ADI | RESİM NO | MONTAJ NO | AÇIKLAMALAR |

ISUZU - KARSAN - BMC

NE 5001 00

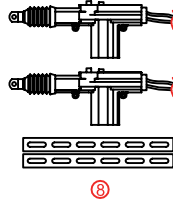
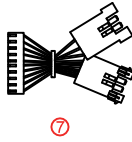
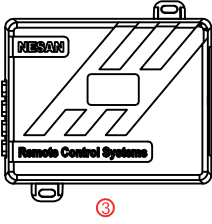
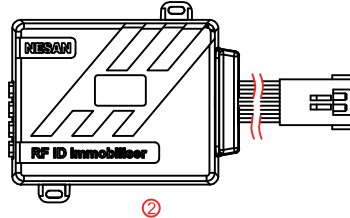

MERKEZİ KİLİT / IMMOBİLİZER SETİ

| | | | | |
|------|--|---------------|-----------|--------------------|
| 2 | MERKEZİ KİLİT SOLENOİDİ VE BAĞLANTI ELEMANLARI | NE 4005 00 | 8 | 24 V |
| 1 | KABLAJ TAKIMI | NE 4008 00 | 7 | |
| 1 | ANTEN KABLAJ TAKIMI | NE 4007 00 | 6 | |
| 1 | UYARI LEDİ | NE 4006 00 | 5 | |
| 1 | ANTEN | NE 4001 24 04 | 4 | |
| 1 | REMOTE CONTROL SYSTEMS ALICI MODULÜ | NE 4004 24 | 3 | 24 V |
| 1 | RF ID IMMOBİLİZER MODUL TAKIMI | NE 4001 24 | 2 | 24 V |
| 2 | UZAKTAN KUMANDA ANAHTARI | NE 4003 00 | 1 | ŞİFRESİZ ANAHTARLI |
| ADET | PARÇA ADI | RESİM NO | MONTAJ NO | AÇIKLAMALAR |

ISUZU - KARSAN - BMC

NE 5002 00

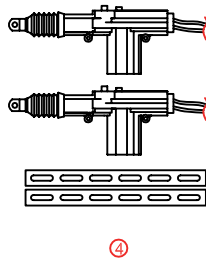
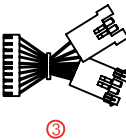
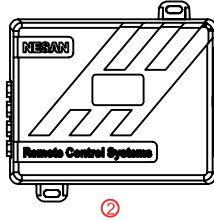
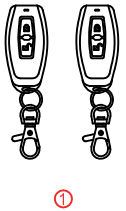

UZAKTAN KUMANDA MERKEZİ KİLİT SİSTEMİ

| | | | | |
|------|--|------------|-----------|-------------|
| 2 | MERKEZİ KİLİT SOLENOİDİ VE BAĞLANTI ELEMANLARI | NE 4005 00 | 4 | 24 V |
| 1 | KABLAJ TAKIMI | NE 4008 00 | 3 | |
| 1 | REMOTE CONTROL SYSTEMS ALICI MODULÜ | NE 4004 24 | 2 | 24 V |
| 2 | UZAKTAN KUMANDA ANAHTARI | NE 4003 01 | 1 | |
| ADET | PARÇA ADI | RESİM NO | MONTAJ NO | AÇIKLAMALAR |

ISUZU - KARSAN - BMC

NE 5004 00

UZAKTAN KUMANDA ve IMMOBİLİZER SİSTEMİ

REMOTE KEYLESS ENTRY & IMMOBİLİZER SYSTEMS

SCHLÜSSELLOSE FERNBEDIENUNG & WEGFAHRSPERRE SYSTEME



NE 5006 00

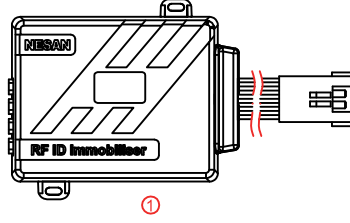

IMMOBİLİZER + ANTEN + KABLOLAMA SETİ

| | | | | |
|------|--------------------------------|---------------|-----------|-------------|
| 1 | ANTEN KABLAJ TAKIMI | NE 4007 00 | 4 | |
| 1 | UYARI LEDİ | NE 4006 00 | 3 | |
| 1 | ANTEN | NE 4001 24 04 | 2 | |
| 1 | RF ID IMMOBİLİZER MODÜL TAKIMI | NE 4001 24 | 1 | 24 V |
| ADET | PARÇA ADI | RESİM NO | MONTAJ NO | AÇIKLAMALAR |

ISUZU - KARSAN - BMC

NE 5007 00

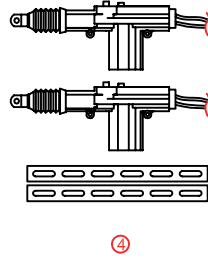
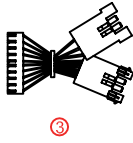
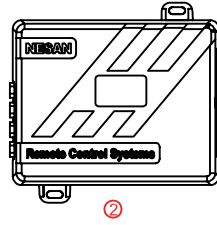

UZAKTAN KUMANDA MERKEZİ KİLİT SİSTEMİ

| | | | | |
|------|--|------------|-----------|--------------------|
| 2 | MERKEZİ KİLİT SOLENOİDİ VE BAĞLANTI ELEMANLARI | NE 4005 00 | 4 | 24 V |
| 1 | KABLAJ TAKIMI | NE 4008 00 | 3 | |
| 1 | REMOTE CONTROL SYSTEMS ALICI MODÜLÜ | NE 4004 24 | 2 | 24 V |
| 2 | UZAKTAN KUMANDA ANAHTARI | NE 4003 05 | 1 | ŞİFRESİZ ANAHTARLI |
| ADET | PARÇA ADI | RESİM NO | MONTAJ NO | AÇIKLAMALAR |

** Transponder şifreli Anahtar

ISUZU - KARSAN - BMC

NE 5008 00

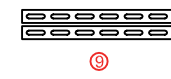
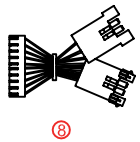
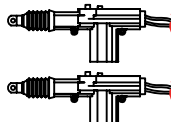
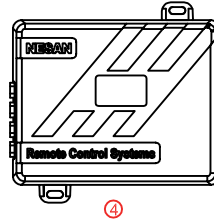
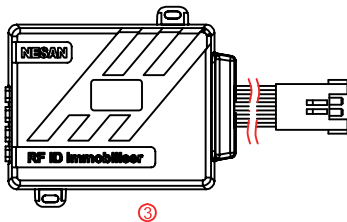
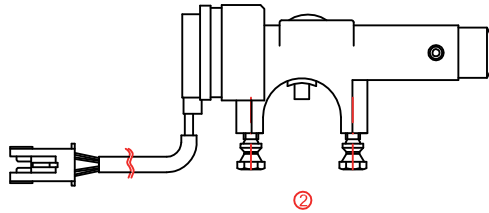

MERKEZİ KİLİT / IMMOBİLİZER SETİ

| | | | | |
|------|--|---------------|-----------|-------------------|
| 2 | MERKEZİ KİLİT SOLENOİDİ VE BAĞLANTI ELEMANLARI | NE 4005 00 | | 24 V |
| 1 | KABLAJ TAKIMI | NE 4008 00 | 8 | |
| 1 | ANTEN KABLAJ TAKIMI | NE 4007 00 | 7 | |
| 1 | UYARI LEDİ | NE 4006 00 | 6 | |
| 1 | ANTEN | NE 4001 24 04 | 5 | |
| 1 | REMOTE CONTROL SYSTEMS ALICI MODÜLÜ | NE 4004 24 | 4 | 24 V |
| 1 | RF ID IMMOBİLİZER MODÜL TAKIMI | NE 4001 24 | 3 | 24 V |
| 1 | KONTAK ANAHTARI | NS 141 00 | 2 | |
| 2 | UZAKTAN KUMANDA ANAHTARI | NE 4003 02 | 1 | ŞİFRELI ANAHTARLI |
| ADET | PARÇA ADI | RESİM NO | MONTAJ NO | AÇIKLAMALAR |

BMC



NESAN®

UZAKTAN KUMANDA ve IMMOBİLİZER SİSTEMİ

REMOTE KEYLESS ENTRY & IMMOBİLİZER SYSTEMS

SCHLÜSSELLOSE FERNBEDIENUNG & WEGFAHRSPERRE SYSTEME

NE 5008 01

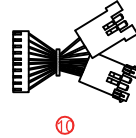
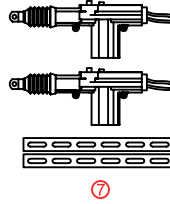
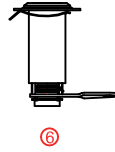
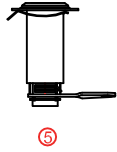
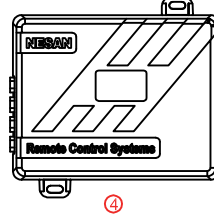
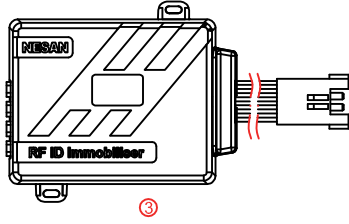
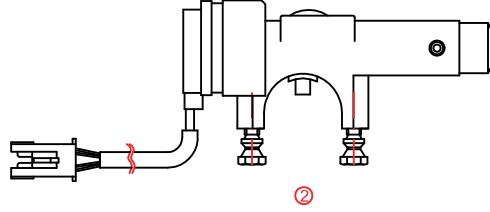
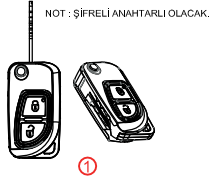

MERKEZİ KİLİT / IMMOBİLİZER SETİ

| | | | | |
|------|--|---------------|-----------|-------------------|
| 2 | MERKEZİ KİLİT SOLENOİDİ VE BAĞLANTI ELEMANLARI | NE 4005 00 | 11 | 24 V |
| 1 | KABLAJ TAKIMI | NE 4008 00 | 10 | |
| 1 | ANTEN KABLAJ TAKIMI | NE 4007 00 | 9 | |
| 1 | UYARI LEDİ | NE 4006 00 | 8 | |
| 1 | ANTEN | NE 4001 24 04 | 7 | |
| 1 | DIŞ KAPI KOLU KİLİDİ (SOL) | NS 902 01 | 6 | |
| 1 | DIŞ KAPI KOLU KİLİDİ (SAĞ) | NS 902 00 | 5 | |
| 1 | REMOTE CONTROL SYSTEMS ALICI MODÜLÜ | NE 4004 24 | 4 | 24 V |
| 1 | RF ID IMMOBİLİSER MODÜL TAKIMI | NE 4001 24 | 3 | 24 V |
| 1 | KONTAK ANAHTARI | NS 141 00 | 2 | |
| 2 | UZAKTAN KUMANDA ANAHTARI | NE 4003 02 | 1 | ŞİFRELI ANAHTARLI |
| ADET | PARÇA ADI | RESİM NO | MONTAJ NO | AÇIKLAMALAR |

BMC

NE 5009 00

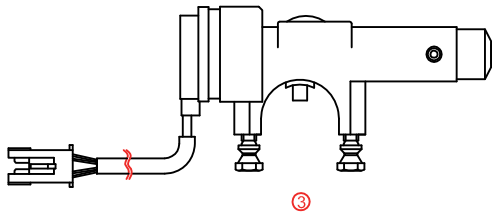
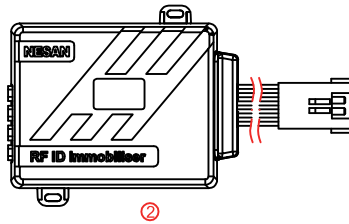

IMMOBİLİZER SETİ + KONTAK ANAHTARLI

| | | | | |
|------|--------------------------------|---------------|-----------|-------------------|
| 1 | ANTEN KABLAJ TAKIMI | NE 4007 00 | 6 | |
| 1 | UYARI LEDİ | NE 4006 00 | 5 | |
| 1 | ANTEN | NE 4001 24 04 | 4 | |
| 1 | KONTAK ANAHTARI | NS 141 00 | 3 | |
| 1 | RF ID IMMOBİLİSER MODÜL TAKIMI | NE 4001 24 | 2 | 24 V |
| 2 | UZAKTAN KUMANDA ANAHTARI | NE 4003 00 | 1 | ŞİFRELI ANAHTARLI |
| ADET | PARÇA ADI | RESİM NO | MONTAJ NO | AÇIKLAMALAR |

BMC

UZAKTAN KUMANDA ve IMMOBİLİZER SİSTEMİ

REMOTE KEYLESS ENTRY & IMMOBİLİZER SYSTEMS

SCHLÜSSELLOSE FERNBEDIENUNG & WEGFAHRSPERRE SYSTEME



NE 5013 01

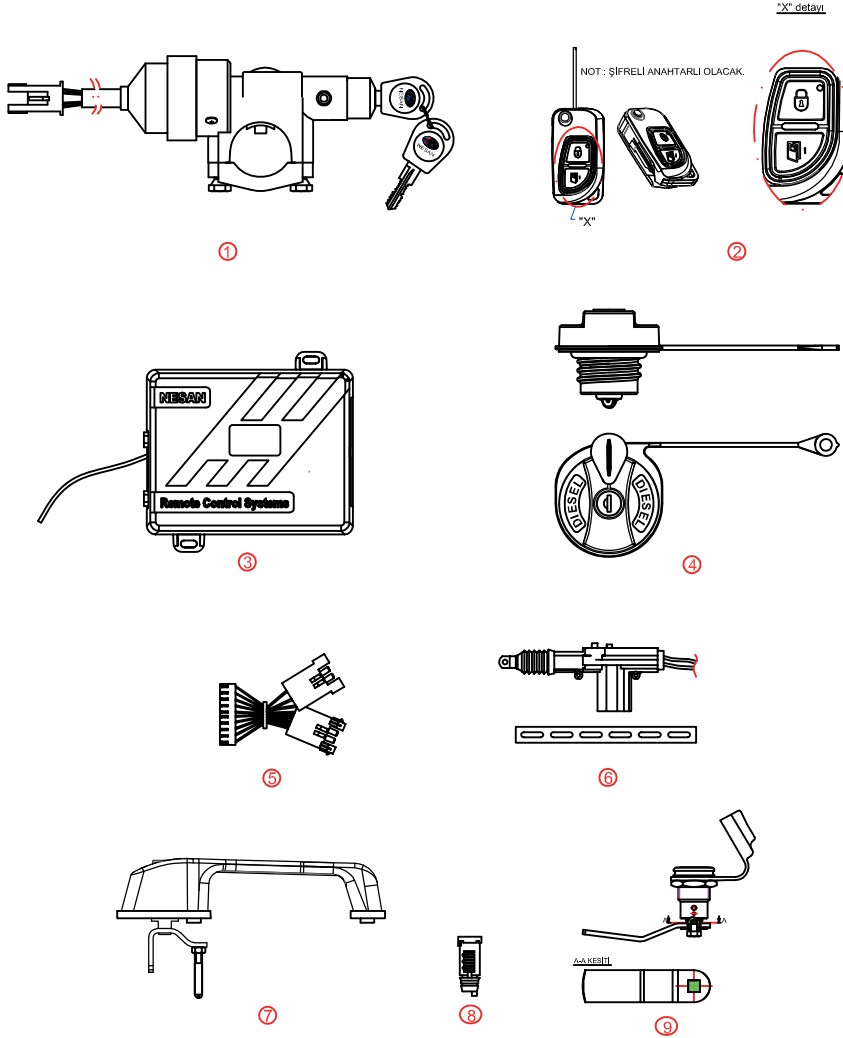

UZAKTAN KUMANDA MERKEZİ KİLİT SİSTEMİ

| | | | | |
|------|--|------------|-----------|-------------------|
| 1 | ARKA KAPAK KİLİDİ | NS 923 00 | 9 | |
| 1 | SERVİS KAPI KİLİT GÖBEĞİ FİŞEĞİ | NS 937 05 | 8 | |
| 1 | KAPI KOLU | NS 946 10 | 7 | |
| 1 | MERKEZİ KİLİT SOLENOİDİ VE BAĞLANTI ELEMANLARI | NE 4008 11 | 6 | 12 V |
| 1 | KABLAJ TAKIMI | NE 4008 02 | 5 | |
| 1 | DEPO KAPAĞI | NS 851 10 | 4 | |
| 1 | REMÖTE CONTROL SYSTEMS ALICI MODÜLÜ | NE 4008 21 | 3 | 12 V |
| 2 | UZAKTAN KUMANDA ANAHTARI (KİLİT-KAPI) | NE 4003 03 | 2 | ŞİFRELI ANAHTARLI |
| 1 | KONTAK ANAHTARI | NS 140 06 | 1 | |
| ADET | PARÇA ADI | RESİM NO | MONTAJ NO | AÇIKLAMALAR |

NOT:

MODUL ALGILAMA MESAFESİ : AÇIK ALANDA Min. 50m
TEPKİ ZAMANLARI : ŞÖFÖR KAPISI = Max. 300ms. / SERVİS KAPISI : Max. 1,5
FLAŞÖR ZAMANLARI : ŞÖFÖR KAPISI = AÇMA 1500 ms. / KAPAMA 5000 ms.

KARSAN (KR.CSX01.730A0007)

NE 5014 01

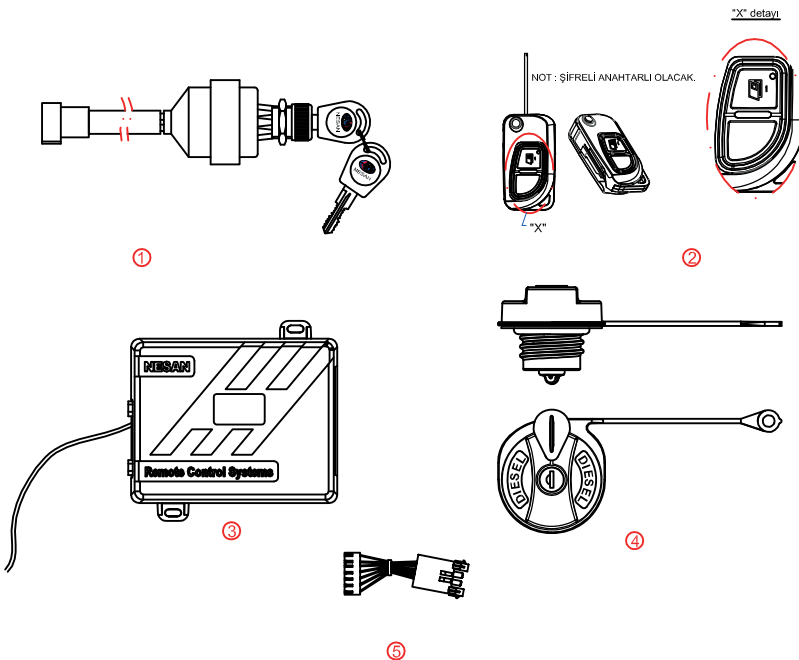

UZAKTAN KUMANDA MERKEZİ KİLİT SİSTEMİ

| | | | | |
|------|-------------------------------------|------------|-----------|-------------------|
| 1 | KABLAJ TAKIMI | NE 4008 02 | 5 | |
| 1 | DEPO KAPAĞI | NS 851 10 | 4 | |
| 1 | REMÖTE CONTROL SYSTEMS ALICI MODÜLÜ | NE 4008 20 | 3 | 24 V |
| 2 | UZAKTAN KUMANDA ANAHTARI (KAPI) | NE 4003 04 | 2 | ŞİFRELI ANAHTARLI |
| 1 | KONTAK ANAHTARI | NS 105 54 | 1 | |
| ADET | PARÇA ADI | RESİM NO | MONTAJ NO | AÇIKLAMALAR |

KARSAN (KR.CXL01.731A0011)

NE 5015 01

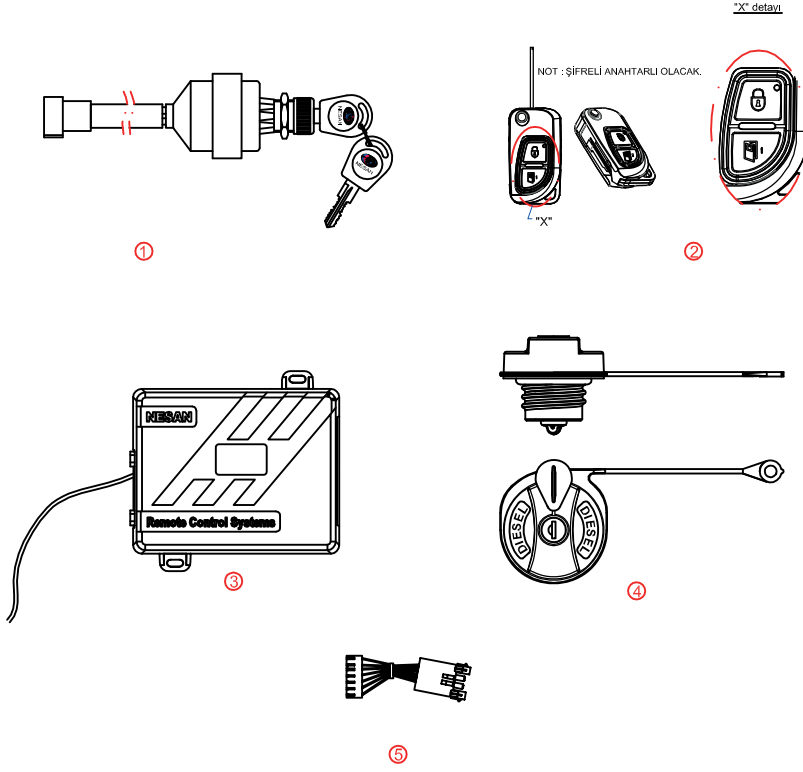

UZAKTAN KUMANDA MERKEZİ KİLİT SİSTEMİ

| | | | | |
|------|---------------------------------------|------------|-----------|-------------------|
| 1 | KABLAJ TAKIMI | NE 4008 01 | 5 | |
| 1 | DEPO KAPAĞI | NS 851 10 | 4 | |
| 1 | REMOTE CONTROL SYSTEMS ALICI MODULÜ | NE 4008 22 | 3 | 24 V |
| 2 | UZAKTAN KUMANDA ANAHTARI (KİLİT-KAPI) | NE 4003 03 | 2 | ŞİFRELI ANAHTARLI |
| 1 | KONTAK ANAHTARI | NS 105 54 | 1 | |
| ADET | PARÇA ADI | RESİM NO | MONTAJ NO | AÇIKLAMALAR |

KARSAN (KR.MXL01.731A0011)

NE 5016 01

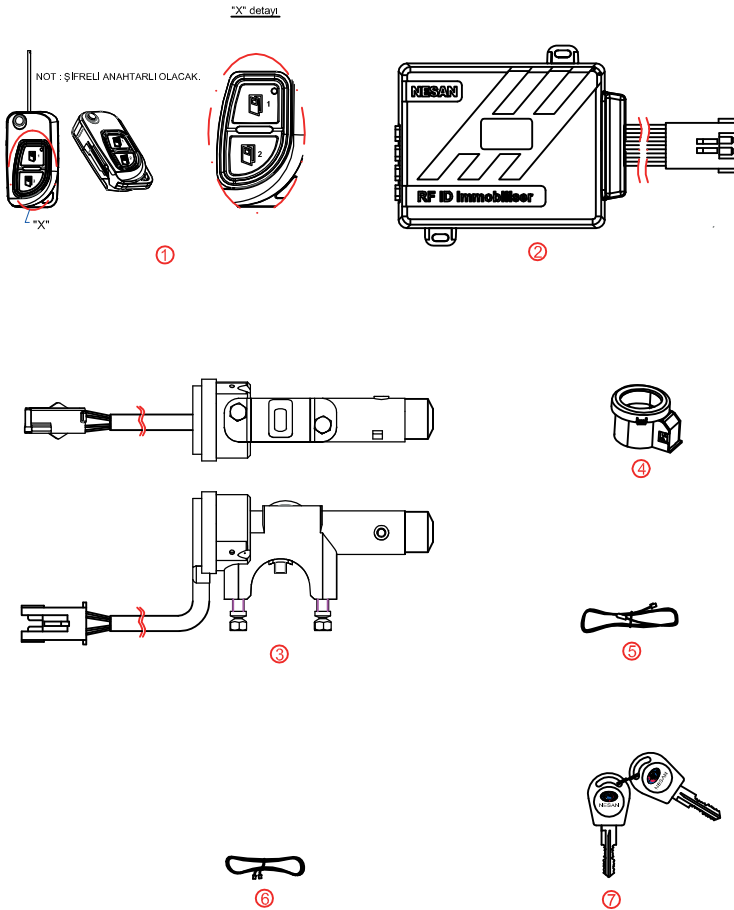

IMMOBİLİZER SETİ + KONTAK ANAHTARLI

| | | | | |
|------|--------------------------------------|---------------|-----------|-------------------|
| 2 | NESAN ANAHTAR | NS 950 00 13 | 7 | |
| 1 | ANTEN KABLAJ TAKIMI | NE 4007 00 | 6 | |
| 1 | UYARI LEDİ | NE 4006 00 | 5 | |
| 1 | ANTEN | NE 4001 24 04 | 4 | |
| 1 | KONTAK ANAHTARI | NS 141 16 | 3 | |
| 1 | RF ID IMMOBİLİZER MODUL TAKIMI | NE 4001 24 | 2 | 24 V |
| 2 | UZAKTAN KUMANDA ANAHTARI (KAPI-KAPI) | NE 4003 06 | 1 | ŞİFRELI ANAHTARLI |
| ADET | PARÇA ADI | RESİM NO | MONTAJ NO | AÇIKLAMALAR |

ISUZU

UZAKTAN KUMANDA ve IMMOBİLİZER SİSTEMİ

REMOTE KEYLESS ENTRY & IMMOBİLİZER SYSTEMS

SCHLÜSSELLOSE FERNBEDIENUNG & WEGFAHRSPERRE SYSTEME

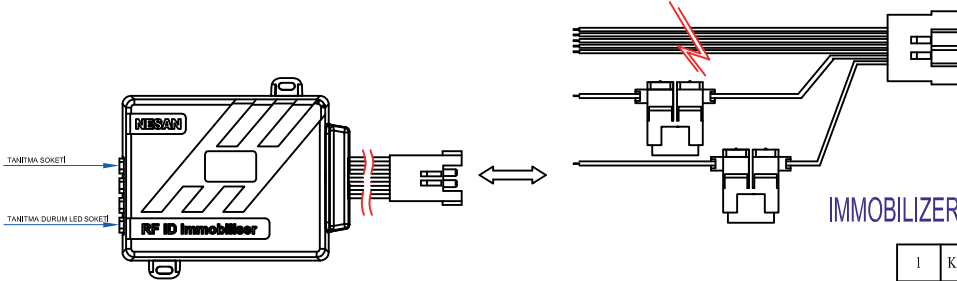

IMMOBİLİZER + RF REMOTE + KONTAK ANAHTARLARI

| | | | | |
|------|--------------------------------------|---------------|-----------|-----------------|
| 1 | KABLAJ TAKIMI | NE 4008 03 | 8 | |
| 1 | REMOTE CONTROL SYSTEMS ALICI MODULÜ | NE 4008 23 | 7 | 24 V |
| 1 | KONTAK ANAHTARI | NS 141 16 | 6 | |
| 2 | NESAN ANAHTAR | NS 950 00 13 | 5 | |
| 1 | ANTEN KABLAJ TAKIMI | NE 4007 00 | 4 | |
| 1 | ANTEN | NE 4001 24 04 | 3 | |
| 1 | RF ID IMMOBİLİZER MODUL TAKIMI | NE 4001 24 | 2 | 24 V |
| 2 | UZAKTAN KUMANDA ANAHTARI (KAPI-KAPI) | NE 4003 06 | 1 | ŞİFRELI ANAHTAR |
| ADET | PARÇA ADI | RESİMNÖ | MONTAJ NO | AÇIKLAMALAR |

ISUZU

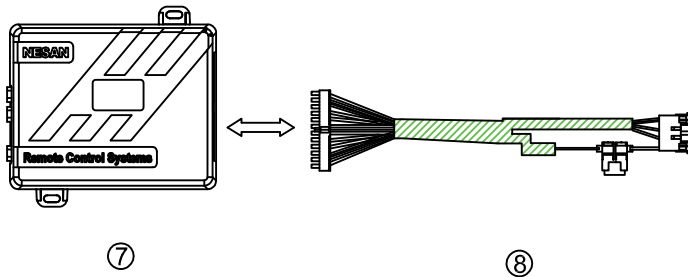
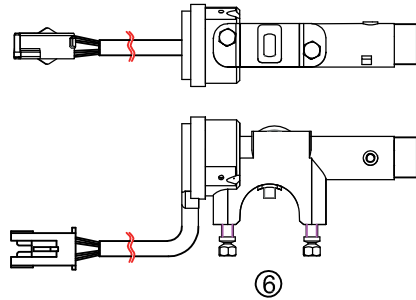
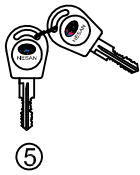
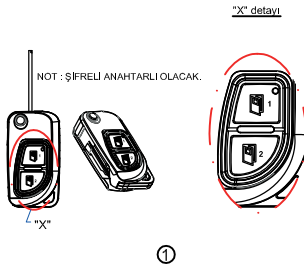

NE 4003 00

Nesan'ın Immobilizer Sistemine Uygundur. Diğer Sistemler İle Çalışmaz.

The Remote Controlling Keys Are Applicable For Nesan Immobilizer Systems Only.
Der Fernsteuer SchlüsselN Sind Nur Für Nesan Wegfahrsperrn.

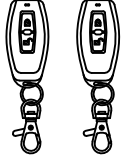
NE 4003 01

Nesan'ın Immobilizer Sistemine Uygundur. Diğer Sistemler İle Çalışmaz.

The Remote Controlling Keys Are Applicable For Nesan Immobilizer Systems Only.
Der Fernsteuer SchlüsselN Sind Nur Für Nesan Wegfahrsperrn.

ADBLUE LEVEL SENSORS / NE 4002 TYPE



Mechanical

| | |
|------------------|---|
| Dimension | Min. length 200mm (8") Max. length 750mm (30") |
| Fitting | Bayonet fitting |

Environmental

| | |
|-----------------------|---|
| Max. Pressure | : 1.0 Bar (14.5 psi) |
| Operating Temp | : -40 °C to +85 °C (-40 °F+185 °F) |
| Sealing | : IP67 |
| Temp. sensing | : NTC thermistor 1K Ω or 3.3 K Ω \pm 5% at 25° or customer specified |

Electrical

| | |
|------------------|---|
| Output | : Any value between 8 to 440 Ω |
| Connector | : AMP Superseal as standards with 200mm (8") length. Optionally, others can be |

FUEL LEVEL SENSORS / NE 4004 TYPE



Mechanical

| | |
|------------------|---|
| Dimension | Min. length 200mm (8") Max. length 750mm (30") |
| Fitting | Bayonet fitting |

Environmental

| | |
|-----------------------|------------------------------------|
| Max. Pressure | : 1.0 Bar (14.5 psi) |
| Operating Temp | : -40 °C to +85 °C (-40 °F+185 °F) |
| Sealing | : IP67 |

Electrical

| | |
|------------------|---|
| Output | : Any value between 8 to 440 Ω |
| Connector | : AMP Superseal as standards with 200mm (8") length. Optionally, others can be |

**NESAN**[®]

ADBLUE SEVİYE SENSÖRLERİ LEVEL SENSORS (ADBLUE)

FÜLLSTANDSSENSOREN

| | | | | |
|----------------------|---|--|--|------------|
| BMC | <p>TİP : ADBLUE SEVİYE GÖSTERGE SENSORU EURO 4</p> <p>L BOYU : 385mm</p> <p>FİLTRE : 350 MESH</p> <p>SIZDIRMAZLIK : IP67</p> <p>SOKET : 4'LÜ YASSI SOKET AMP : 282106-1</p> <p>* Toplam 14 aralıkta 21mm stepler ile ölçüm yapılmaktadır.</p> | | | NE 4002 00 |
| TEMSA | <p>TİP : ADBLUE SEVİYE GÖSTERGE SENSORU</p> <p>L BOYU : 370mm</p> <p>FİLTRE : 350 MESH</p> <p>SIZDIRMAZLIK : IP67</p> <p>SOKET : SOKET - İKİLİ - DIŞI (2 ADET) AMP : 282104-1</p> <p>* Toplam 14 aralıkta 21mm stepler ile ölçüm yapılmaktadır.</p> | | | NE 4002 01 |
| BMC | <p>TİP : ADBLUE SEVİYE GÖSTERGE SENSORU EURO 5</p> <p>L BOYU : 385mm</p> <p>FİLTRE : 350 MESH</p> <p>SIZDIRMAZLIK : IP67</p> <p>SOKET : 4'LÜ YASSI SOKET AMP : 282106-1</p> <p>* Toplam 14 aralıkta 21mm stepler ile ölçüm yapılmaktadır.</p> | | | NE 4002 02 |
| FORD (DC46-5J241-DA) | <p>TİP : ADBLUE SEVİYE GÖSTERGE SENSORU</p> <p>L BOYU : 435mm</p> <p>FİLTRE : 350 MESH</p> <p>SIZDIRMAZLIK : IP67</p> <p>SOKET : BAYONET TİP SOKET DIN 72585</p> <p>* Toplam 17 aralıkta 21mm stepler ile ölçüm yapılmaktadır.</p> | | | NE 4002 03 |
| FORD (DC46-5J241-EA) | <p>TİP : ADBLUE SEVİYE GÖSTERGE SENSORU</p> <p>L BOYU : 435mm</p> <p>FİLTRE : 350 MESH</p> <p>SIZDIRMAZLIK : IP67</p> <p>SOKET : BAYONET TİP SOKET DIN 72585</p> <p>* Toplam 17 aralıkta 21mm stepler ile ölçüm yapılmaktadır.</p> | | | NE 4002 04 |

ADBLUE SEVİYE SENSÖRLERİ LEVEL SENSORS (ADBLUE)

FÜLLSTANDSENSOREN



NESAN®

| | | | |
|------------|--|--|--------------------------------|
| NE 4002 06 | | <p>TİP : ADBLUE SEVİYE GÖSTERGE SENSÖRÜ</p> <p>L BOYU : 585mm</p> <p>FİLTRE : 350 MESH</p> <p>SIZDIRMAZLIK : IP67</p> <p>SOKET : BAYONET TİP SOKET DIN 72585</p> <p>* Toplam 23 aralıkta 21mm stepler ile ölçüm yapılmaktadır.</p> | FORD (DC46-5J241-CA) |
| NE 4002 07 | | <p>TİP : ADBLUE SEVİYE GÖSTERGE SENSÖRÜ</p> <p>L BOYU : 585mm</p> <p>FİLTRE : 350 MESH</p> <p>SIZDIRMAZLIK : IP67</p> <p>SOKET : BAYONET TİP SOKET DIN 72585</p> <p>* Toplam 23 aralıkta 21mm stepler ile ölçüm yapılmaktadır.</p> | FORD (DC46-5J241-FA) |
| NE 4002 08 | | <p>TİP : ADBLUE SEVİYE GÖSTERGE SENSÖRÜ</p> <p>L BOYU : 640mm</p> <p>FİLTRE : 350 MESH</p> <p>SIZDIRMAZLIK : IP67</p> <p>SOKET : BAYONET TİP SOKET DIN 72585</p> <p>* Hava Tahliyesi</p> <p>* Toplam 26 aralıkta 21mm stepler ile ölçüm yapılmaktadır.</p> | FORD |
| NE 4002 10 | | <p>TİP : ADBLUE SEVİYE GÖSTERGE SENSÖRÜ</p> <p>L BOYU : 385mm</p> <p>FİLTRE : 100 MESH</p> <p>SIZDIRMAZLIK : IP67</p> <p>SOKET : 3'lü YASSI SOKET AMP 282105-1</p> <p>* Toplam 15 aralıkta 21mm stepler ile ölçüm yapılmaktadır.</p> | KARSAN FLOTEKS (H10.01.006) |
| NE 4002 11 | | <p>TİP : ADBLUE SEVİYE GÖSTERGE SENSÖRÜ</p> <p>L BOYU : 245mm</p> <p>FİLTRE : 35 MESH</p> <p>SIZDIRMAZLIK : IP67</p> <p>SOKET : BAYONET TİP SOKET DIN 72585</p> <p>* Toplam 10 aralıkta 15mm stepler ile ölçüm yapılmaktadır.</p> | OTOKAR |



NESAN®

ADBLUE SEVİYE SENSÖRLERİ LEVEL SENSORS (ADBLUE)

FÜLLSTANDSENSOREN

| | | | |
|--------------|--|--|-------------------|
| <p>ISUZU</p> | <p>TİP : ADBLUE SEVİYE GÖSTERGE SENSÖRÜ EURO 5</p> <p>L BOYU : 310mm</p> <p>FİLTRE : 35 MESH</p> <p>SIZDIRMAZLIK : IP67</p> <p>SOKET : 4'LÜ YASSI SOKET AMP : 282106-1</p> <p>* Toplam 12 aralıkta 15mm stepler ile ölçüm yapılmaktadır.</p> | | <p>NE 4002 12</p> |
| <p>ISUZU</p> | <p>TİP : ADBLUE SEVİYE GÖSTERGE SENSÖRÜ EURO 6</p> <p>L BOYU : 310mm</p> <p>FİLTRE : 35 MESH</p> <p>SIZDIRMAZLIK : IP67</p> <p>SOKET : 4'LÜ YASSI SOKET AMP : 282106-1</p> <p>* Toplam 12 aralıkta 15mm stepler ile ölçüm yapılmaktadır.</p> | | <p>NE 4002 13</p> |

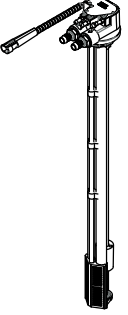
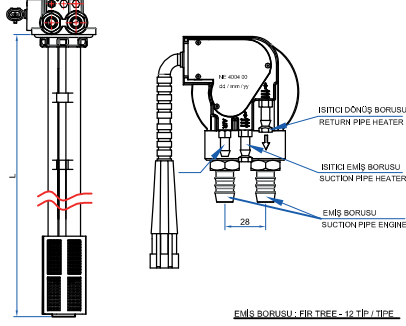
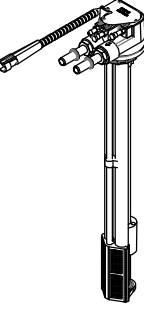
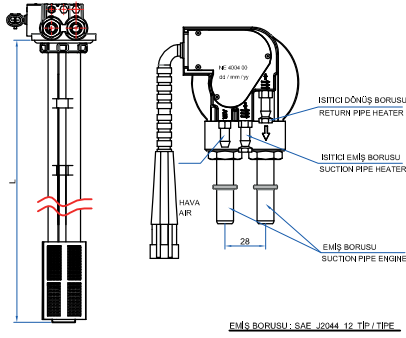
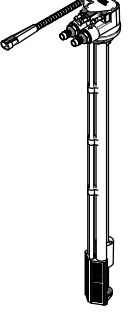
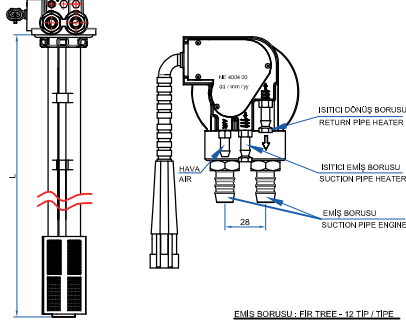
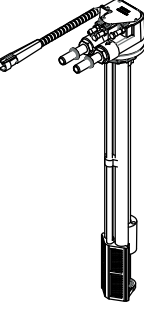
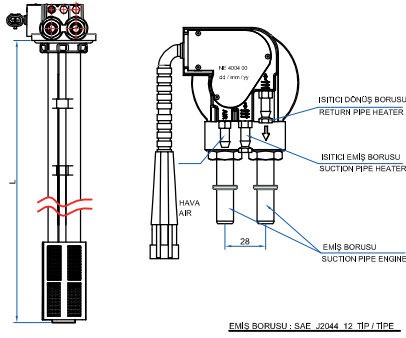
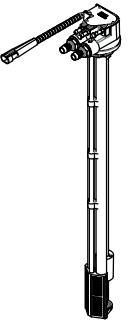
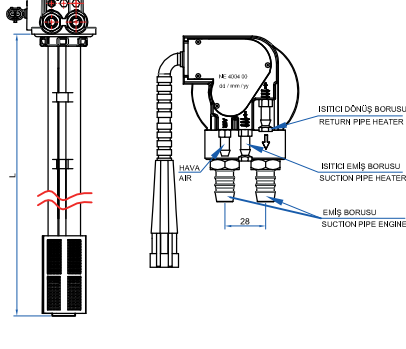









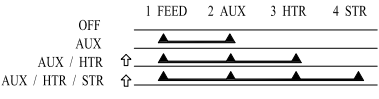



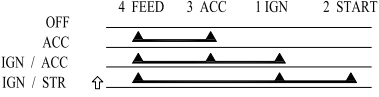



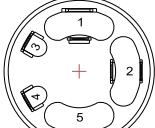



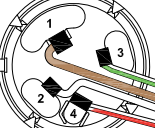

| | | | | |
|-------------------|---|--|---|-----------------------------|
| NE 4004 00 |  |  <p>İSTİTİCİ DÖNÜŞ BORUSU RETURN PIPE HEATER</p> <p>İSTİTİCİ EMİŞ BORUSU SUCTION PIPE HEATER</p> <p>EMİŞ BORUSU SUCTION PIPE ENGINE</p> <p>EMİŞ BORUSU : FIR TREE - 12 TİP / TİPE</p> | <p>TİP : YAKIT SEVİYE GÖSTERGE SENSÖRÜ</p> <p>L BOYU : 473mm</p> <p>FİLTRE : 350 MESH</p> <p>SIZDIRMAZLIK : IP67</p> <p>SOKET : SOKET - İKİLİ - DİŞİ AMP : 282104-1</p> <p>* Toplam 19 aralıkta 21mm stepler ile ölçüm yapılmaktadır.</p> | <p>FORD (DC46 9275 GA)</p> |
| NE 4004 01 |  |  <p>İSTİTİCİ DÖNÜŞ BORUSU RETURN PIPE HEATER</p> <p>İSTİTİCİ EMİŞ BORUSU SUCTION PIPE HEATER</p> <p>EMİŞ BORUSU SUCTION PIPE ENGINE</p> <p>HAVA FİR AIR</p> <p>EMİŞ BORUSU : SAE J2044 12 TİP / TİPE</p> | <p>TİP : YAKIT SEVİYE GÖSTERGE SENSÖRÜ</p> <p>L BOYU : 473mm</p> <p>FİLTRE : 350 MESH</p> <p>SIZDIRMAZLIK : IP67</p> <p>SOKET : SOKET - İKİLİ - DİŞİ AMP : 282104-1</p> <p>* Toplam 19 aralıkta 21mm stepler ile ölçüm yapılmaktadır.</p> | <p>FORD (DC46 9275 FA)</p> |
| NE 4004 02 |  |  <p>İSTİTİCİ DÖNÜŞ BORUSU RETURN PIPE HEATER</p> <p>İSTİTİCİ EMİŞ BORUSU SUCTION PIPE HEATER</p> <p>EMİŞ BORUSU SUCTION PIPE ENGINE</p> <p>HAVA FİR AIR</p> <p>EMİŞ BORUSU : FIR TREE - 12 TİP / TİPE</p> | <p>TİP : YAKIT SEVİYE GÖSTERGE SENSÖRÜ</p> <p>L BOYU : 698mm</p> <p>FİLTRE : 350 MESH</p> <p>SIZDIRMAZLIK : IP67</p> <p>SOKET : SOKET - İKİLİ - DİŞİ AMP : 282104-1</p> <p>* Toplam 30 aralıkta 21mm stepler ile ölçüm yapılmaktadır.</p> | <p>FORD (DC46 9275 EA)</p> |
| NE 4004 03 |  |  <p>İSTİTİCİ DÖNÜŞ BORUSU RETURN PIPE HEATER</p> <p>İSTİTİCİ EMİŞ BORUSU SUCTION PIPE HEATER</p> <p>EMİŞ BORUSU SUCTION PIPE ENGINE</p> <p>HAVA FİR AIR</p> <p>EMİŞ BORUSU : SAE J2044 12 TİP / TİPE</p> | <p>TİP : YAKIT SEVİYE GÖSTERGE SENSÖRÜ</p> <p>L BOYU : 698mm</p> <p>FİLTRE : 350 MESH</p> <p>SIZDIRMAZLIK : IP67</p> <p>SOKET : SOKET - İKİLİ - DİŞİ AMP : 282104-1</p> <p>* Toplam 30 aralıkta 21mm stepler ile ölçüm yapılmaktadır.</p> | <p>FORD (DC46 9275 HA)</p> |
| NE 4004 10 |  |  <p>İSTİTİCİ DÖNÜŞ BORUSU RETURN PIPE HEATER</p> <p>İSTİTİCİ EMİŞ BORUSU SUCTION PIPE HEATER</p> <p>EMİŞ BORUSU SUCTION PIPE ENGINE</p> <p>HAVA FİR AIR</p> <p>EMİŞ BORUSU : FIR TREE - 12 TİP / TİPE</p> | <p>TİP : YAKIT SEVİYE GÖSTERGE SENSÖRÜ</p> <p>L BOYU : 600mm</p> <p>FİLTRE : 350 MESH</p> <p>SIZDIRMAZLIK : IP67</p> <p>SOKET : SOKET - İKİLİ - DİŞİ AMP : 282104-1</p> <p>* Toplam 25 aralıkta 21mm stepler ile ölçüm yapılmaktadır.</p> | <p>KARSAN</p> |

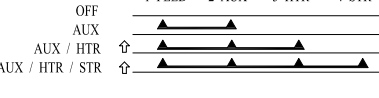
**NESAN®**

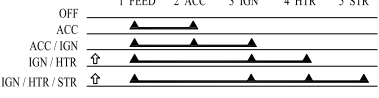
KONTAK ANAHTARLARI

STARTER SWITCHES

ZÜNDSCHALTERN

| | | | |
|---------------------------------------|---|--|--|
| BMC (FATİH/YAVUZ) VOLVO RENAULT | LUCAS - 33884 35703 |  <p>OFF AUX AUX / HTR AUX / HTR / STR</p> <p>1 FEED 2 AUX 3 HTR 4 STR</p> |  <p>NS 101 00</p> |
| NEW HOLLAND(TD SERİSİ) |  <p>HTR / STR HTR OFF AUX AUX / STR</p> <p>1 FEED 2 AUX 3 HTR 4 STR</p> |  <p>DİŞ: M 19x1</p> |  <p>NS 101 01</p> |
| FORD / NEW HOLLAND |  <p>OFF ACC IGN / ACC IGN / STR</p> <p>4 FEED 3 ACC 1 IGN 2 START</p> |  <p>DİŞ: M 19x1</p> |  <p>NS 101 02</p> |
| LAND ROVER RVI NATO |  <p>12 - 24 V</p> <p>OFF AUX / ALT AUX / HTR AUX / STR / HTR</p> <p>1 FEED 2 AUX 3 STR 4 ALT 5 HTR</p> <p>10A / - 16 / 5A 15 / 7.5A</p> |  <p>DİŞ: M 19x1</p> |  <p>NS 101 06</p> |
| BAŞAK (Y.M.) |  <p>OFF AUX AUX / HTR AUX / HTR / STR</p> <p>1 FEED 2 AUX 3 HTR 4 STR</p> |  <p>DİŞ M 20x1</p> |  <p>NS 101 12</p> |
| HİDROMEK |  <p>OFF AUX AUX / HTR AUX / HTR / STR</p> <p>1 FEED 2 AUX 3 HTR 4 STR</p> |  <p>DİŞ: M20x1</p> |  <p>NS 101 13</p> |
| HATTAT |  <p>OFF AUX AUX / HTR AUX / HTR / STR</p> <p>1 FEED 2 AUX 3 HTR 4 STR</p> |  <p>DİŞ: M20x1</p> |  <p>NS 101 14</p> |
| HATTAT |  <p>OFF ACC ACC / IGN IGN / HTR / STR</p> <p>1 FEED 2 ACC 3 IGN 4 HTR 5 STR</p> <p>24 A 13 A 13 A 24 A</p> |  <p>DİŞ M20x1</p> |  <p>NS 101 53</p> |
| BMC (FATİH/BELDE) VOLVO RENAULT |  <p>OFF AUX AUX / HTR AUX / HTR / STR</p> <p>1 FEED 2 AUX 3 HTR 4 STR</p> |  <p>DİŞ: M22x1</p> |  <p>NS 105 00</p> |

KONTAK ANAHTARLARI

STARTER SWITCHES

ZÜNDSCHALTERN



| | | | | |
|-----------|--|-------------------|--|--|
| NS 105 11 | | <p>DiŞ: M22x1</p> | <p>1 FEED 2 AUX 3 HTR 4 STR</p> <p>OFF AUX AUX / HTR AUX / HTR / STR</p> | BAŞAK |
| NS 105 12 | | <p>DiŞ: M22x1</p> | <p>1 FEED 2 AUX 3 HTR 4 STR</p> <p>OFF AUX AUX / HTR AUX / HTR / STR</p> | HİDROMEK |
| NS 105 14 | | <p>DiŞ: M22x1</p> | <p>1 FEED 2 AUX 3 HTR 4 STR</p> <p>OFF AUX AUX / HTR AUX / HTR / STR</p> | MASTAŞ/SANKO ÇUKUROVA MAKİNA |
| NS 105 30 | | <p>DiŞ: M22x1</p> | <p>1 FEED 2 AUX 3 STP 4 STR</p> <p>STP OFF AUX AUX / STR</p> | MARIN |
| NS 105 39 | | <p>DiŞ: M22x1</p> | <p>1 FEED 2 AUX 3 HTR 4 STR</p> <p>OFF AUX AUX / HTR AUX / HTR / STR</p> | VALTRA |
| NS 105 49 | | <p>DiŞ: M22x1</p> | <p>FEED ACC IGN START</p> <p>OFF ACC ACC / IGN IGN / STR</p> | VALTRA |
| NS 150 00 | | <p>DiŞ: M23x1</p> | <p>1 FEED 2 RAD 3 AUX 4 STR</p> <p>OFF RAD RAD / AUX AUX / HTR / STR</p> | (AS250/950 YM 2000>)ASKAM/DODGE/FARGO |
| NS 150 02 | | <p>DiŞ: M23x1</p> | <p>1 FEED 2 RAD 3 AUX 4 STR</p> <p>OFF RAD RAD / AUX AUX / HTR / STR</p> | (AS250/950 YM 2004>)ASKAM/DODGE/FARGO |
| NS 103 00 | | <p>DiŞ: M16x1</p> | <p>1 FEED 2 AUX 3 HTR 4 STR</p> <p>OFF AUX AUX / HTR AUX / HTR / STR</p> | <p>PERKINS - 2846121 2846130 LUCAS - 33820 34228 35641</p> <p>CASE IH / NEW HOLLAND DAVID BROWN MASSEY FERGUSON VALTRA JCB</p> |

**NESAN®**

KONTAK ANAHTARLARI

STARTER SWITCHES

ZÜNDSCHALTERN











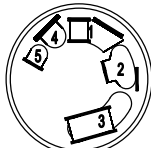
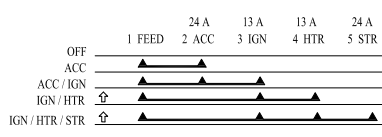





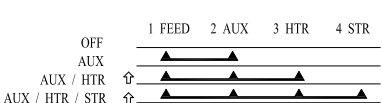

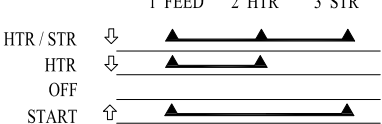

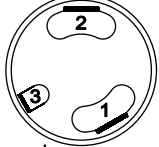
| | | | | | |
|---|---|---|-------------------|--|-----------|
| LUCAS - 35589 | NEW HOLLAND / FORD | <p>1 FEED 2 AUX 3 HTR 4 STR</p> <p>HTR / STR ↓</p> <p>HTR ↓</p> <p>OFF</p> <p>AUX</p> <p>AUX / STR ↑</p> | <p>Dış: M16x1</p> | | NS 103 03 |
| CASE IH MASSEY FERGUSON NATO | LUCAS - 33940 | <p>1 FEED 2 AUX 3 STR</p> <p>OFF</p> <p>AUX</p> <p>AUX / STR ↑</p> | <p>Dış: M16x1</p> | | NS 103 04 |
| CASE IH DAVID BROWN MASSEY FERGUSON NUFFIELD | PERKINS - 2846121 2846130 LUCAS - 33942 | <p>1 FEED 2 AUX 3 HTR 3 HTR 4 STR</p> <p>OFF</p> <p>AUX</p> <p>AUX / HTR ↑</p> <p>AUX / HTR / STR ↑</p> | <p>Dış: M16x1</p> | | NS 103 05 |
| FORD TRAKTÖR | LUCAS - 35327 | <p>12 - 24 V</p> <p>1 FEED 2 AUX 3 STR 4 ALT 5 HTR</p> <p>OFF</p> <p>AUX / ALT</p> <p>AUX / HTR ↑</p> <p>AUX / STR / HTR ↑</p> <p>10A / - 16 / 5A 15 / 7.5A</p> | <p>Dış: M16x1</p> | | NS 103 06 |
| | LUCAS - 35628 | <p>1 FEED 2 AUX 3 HTR 4 STR</p> <p>OFF</p> <p>AUX</p> <p>HTR ↑</p> <p>HTR / STR ↑</p> | <p>Dış: M16x1</p> | | NS 103 07 |
| MASSEY FERGUSON _(35/65/135/165) CASE IH FORD TRAKTÖR | PERKINS - 2846124 LUCAS - 35630 | <p>1 FEED 2 HTR 3 STR</p> <p>HTR / STR ↓</p> <p>HTR ↓</p> <p>OFF</p> <p>START ↑</p> | <p>Dış: M16x1</p> | | NS 103 08 |
| FORD / NEW HOLLAND | | <p>1 FEED 2 SIDE-TAIL 3 HTR 4 AUX 5 STR</p> <p>OFF</p> <p>SIDE/TAIL</p> <p>SIDE/AUX</p> <p>HTR</p> <p>HTR / STR ↑</p> | <p>Dış: M16x1</p> | | NS 103 10 |
| HATTAT / UNIVERSAL | | <p>1 FEED 2 AUX 3 HTR 4 STR</p> <p>OFF</p> <p>AUX</p> <p>AUX / HTR ↑</p> <p>AUX / HTR / STR ↑</p> | <p>Dış: M16x1</p> | | NS 103 15 |
| CASE IH / NEW HOLLAND DAVID BROWN MASSEY FERGUSON _(240/285) VALTRA JCB | PERKINS - 2846121 2846130 LUCAS - 33820 34228 35641 | <p>1 FEED 2 AUX 3 HTR 4 STR</p> <p>OFF</p> <p>AUX</p> <p>AUX / HTR ↑</p> <p>AUX / HTR / STR ↑</p> | <p>Dış: M16x1</p> | | NS 103 17 |



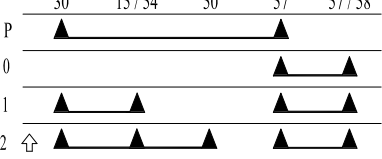

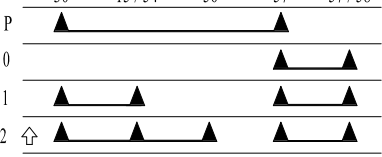

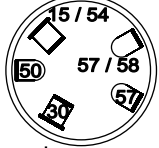
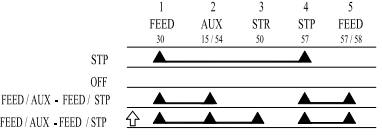

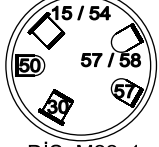
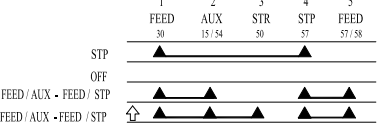

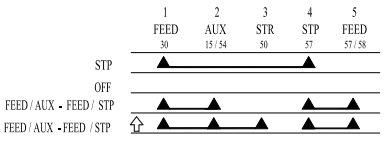
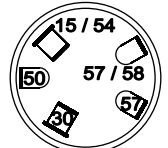

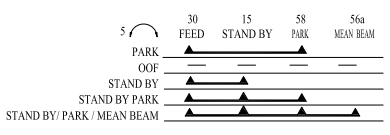
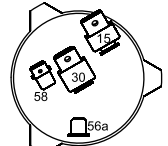

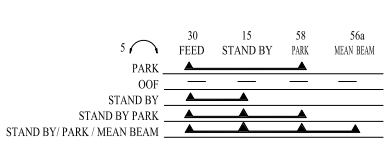
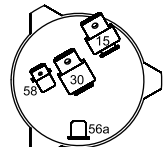

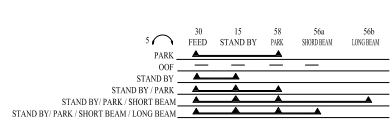
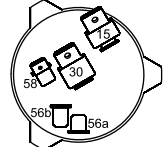

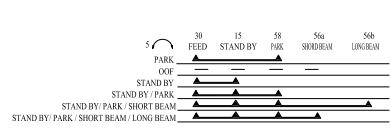
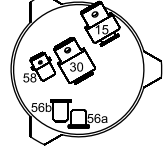
KONTAK ANAHTARLARI

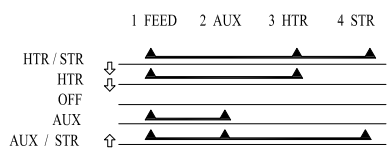
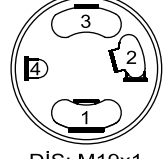
STARTER SWITCHES

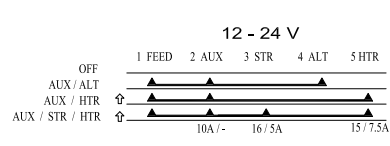
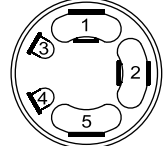
ZÜNDSCHALTERN

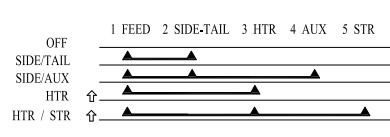
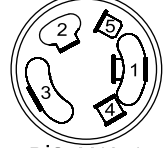

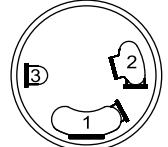
| | | | | |
|-----------|---|---|---|-----------------------------------|
| NS 103 23 |  |  <p>DIŞ: M16x1</p> |  <p>MASSEY FERGUSON^(266/277/3075/3105)</p> | <p>NEOPRENLİ-NEOPRENE COATING</p> |
| NS 103 25 |  |  <p>DIŞ: M16x1</p> |  <p>PERKINS - 2846121 2846130 LUCAS - 33820 34228 35641</p> <p>CASE IH / NEW HOLLAND DAVID BROWN (240/285)MASSEY FERGUSON VALTRA JCB</p> | <p>NEOPRENLİ-NEOPRENE COATING</p> |
| NS 103 28 |  |  <p>DIŞ: M16x1</p> |  <p>PERKINS - 2846121 2846130 LUCAS - 33820 34228 35641</p> <p>CASE IH / NEW HOLLAND DAVID BROWN MASSEY FERGUSON VALTRA JCB</p> | |
| NS 103 31 |  |  <p>DIŞ: M16x1</p> |  <p>BAŞAK</p> | |
| NS 104 00 |  |  <p>DIŞ: M14x1</p> |  <p>JOHN DEERE</p> | |
| NS 106 00 |  |  <p>DIŞ: M22x1</p> |  <p>COBO - 14.159.000</p> <p>CASE / IH ERKUNT (TD/TT SERI/55.46/00.66)FIAT / NEW HOLLAND</p> | |
| NS 106 01 |  |  <p>DIŞ: M22x1</p> |  <p>COBO - 14.159.000</p> <p>FIAT / NEW HOLLAND CASE / IH ERKUNT</p> | |
| NS 107 00 |  |  <p>DIŞ: M22x1</p> |  <p>(55.46)FIAT / NEW HOLLAND TÜMOSAN YAĞMUR TARIM</p> | |
| NS 107 01 |  |  <p>DIŞ: M22x1</p> |  <p>(55.46)FIAT / NEW HOLLAND TÜMOSAN YAĞMUR TARIM</p> | |











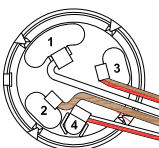
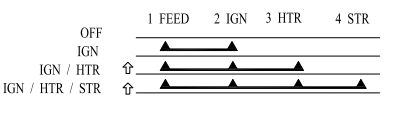

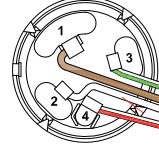
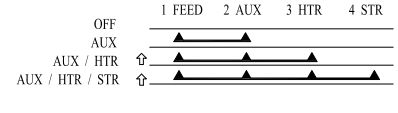

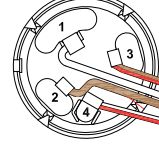
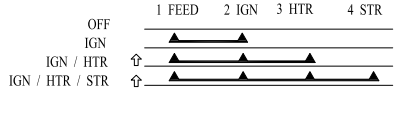

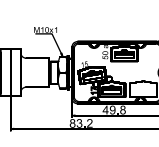
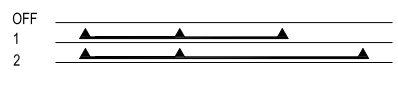
| | | | |
|---|---|---|---|
| <p>ERKUNT MARIN</p> |  |  <p>DİŞ: M22x1</p> |  <p>NS 107 03</p> |
| <p>STEYR / BAŞAK⁽⁷⁶⁸⁾ (E.M.) CASE IH</p> |  |  <p>DİŞ: M26x1,5</p> |  <p>NS 124 00</p> |
| <p>STEYR / BAŞAK⁽⁷⁶⁸⁾ CASE IH</p> |  |  <p>DİŞ: M26x1,5</p> |  <p>NS 124 02</p> |
| <p>JOHN DEERE DEUTZ TRAKTÖR CASE IH FORD TRAKTÖR⁽²⁻³⁻⁵⁰⁰⁰⁾</p> |  |  <p>DİŞ: M26x1,5</p> |  <p>NS 124 03</p> |
| <p>JOHN DEERE DEUTZ TRAKTÖR CASE IH</p> |  |  <p>DİŞ: M26x1,5</p> |  <p>NS 124 04</p> |
| <p>FORD / NEW HOLLAND LUCAS - 35589</p> |  |  <p>DİŞ: M19x1</p> |  <p>NS 127 03</p> |
| <p>FORD / NEW HOLLAND LUCAS - 35327</p> |  |  <p>DİŞ: M19x1</p> |  <p>NS 127 06</p> |
| <p>FORD / NEW HOLLAND^(2-3-5000/6600/6610)</p> |  |  <p>DİŞ: M19x1</p> |  <p>NS 127 10</p> |
| <p>FORD / NEW HOLLAND MASSEY FERGUSON</p> |  |  <p>DİŞ: M19x1</p> |  <p>NS 127 12</p> |

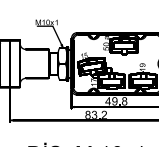
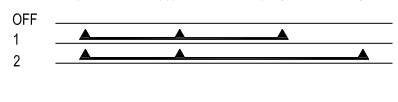

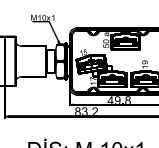
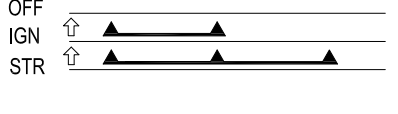

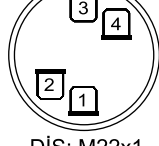
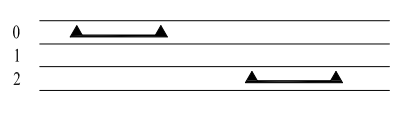

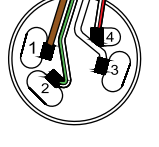
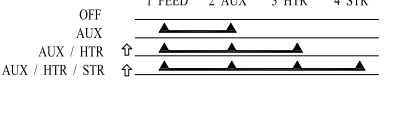

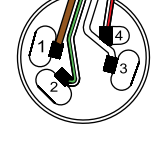
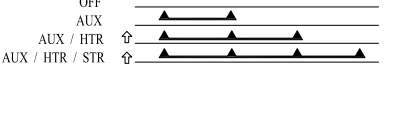

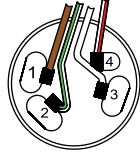

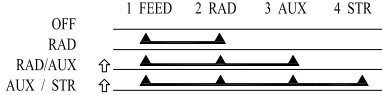
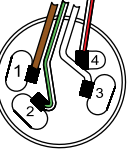

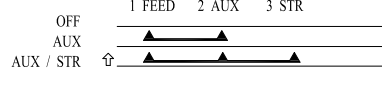
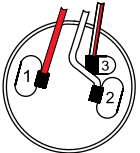
KONTAK ANAHTARLARI

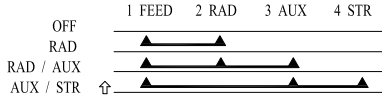
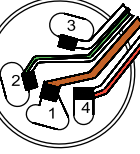
STARTER SWITCHES

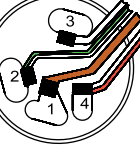
ZÜNDSCHALTERN

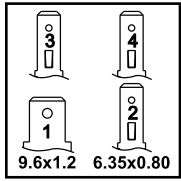
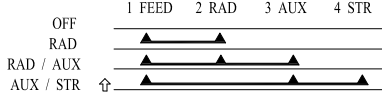
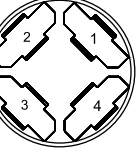

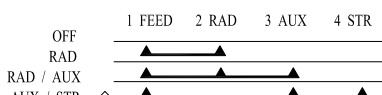
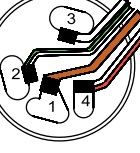
| | | | |
|---|--|--|--|
| <p>NS 133 00</p>  |  <p>DİŞ: M16x1</p> | <p>1 FEED 2 IGN 3 HTR 4 STR</p> <p>OFF IGN IGN / HTR IGN / HTR / STR</p>  | <p>MASSEY FERGUSON^(398T)</p> |
| <p>NS 133 01</p>  |  <p>DİŞ: M16x1</p> | <p>1 FEED 2 AUX 3 HTR 4 STR</p> <p>OFF AUX AUX / HTR AUX / HTR / STR</p>  | <p>HİDROMEK</p> |
| <p>NS 133 02</p>  |  <p>DİŞ: M16x1</p> | <p>1 FEED 2 IGN 3 HTR 4 STR</p> <p>OFF IGN IGN / HTR IGN / HTR / STR</p>  | <p>MASSEY FERGUSON</p> |
| <p>NS 134 00</p>  |  <p>DİŞ: M 10x1</p> | <p>15 FEED 50a HTR 19 AUX 17 STR</p> <p>OFF 1 2</p>  | <p>STEYR / BAŞAK CASE IH</p> |
| <p>NS 134 01</p>  |  <p>DİŞ: M 10x1</p> | <p>15 FEED 50a HTR 19 AUX 17 STR</p> <p>OFF 1 2</p>  | <p>DEUTZ TRAKTÖR FENDT JOHN DEERE BOSCH - 0343008007</p> |
| <p>NS 134 02</p>  |  <p>DİŞ: M 10x1</p> | <p>1 FEED 2 IGN 3 STR</p> <p>OFF IGN STR</p>  | <p>DEUTZ TRAKTÖR FENDT JOHN DEERE</p> |
| <p>NS 135 00</p>  |  <p>DİŞ: M22x1</p> | <p>1 2 3 4</p> <p>0 1 2</p>  | <p>BİSAN RAMZEY</p> |
| <p>NS 102 00</p>  |  | <p>1 FEED 2 AUX 3 HTR 4 STR</p> <p>OFF AUX AUX / HTR AUX / HTR / STR</p>  | <p>BMC MODEL</p> <p>NS 102 00/1 - TERMINAL</p> |
| <p>NS 114 00</p>  |  | <p>1 FEED 2 AUX 3 HTR 4 STR</p> <p>OFF AUX AUX / HTR AUX / HTR / STR</p>  | <p>BMC MODEL</p> <p>NS 114 00/2 - TERMINAL</p> |











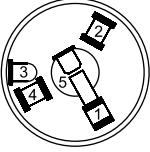

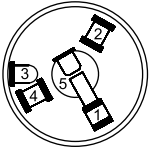

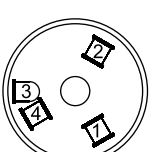

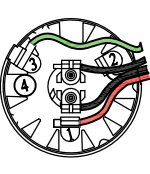
| | | | |
|---|--|---|---|
| <p>BMC MODEL</p> <p>NS 115 00/2 - TERMINAL</p> |  |  |  <p>NS 115 00</p> |
| <p>BMC MODEL</p> <p>NS 116 00/1 - TERMINAL</p> |  |  |  <p>NS 116 00</p> |
| <p>BMC MODEL</p> <p>NS 117 00/2 - TERMINAL</p> |  |  |  <p>NS 117 00</p> |
| <p>BMC MODEL</p> <p>NS 140 00/1 - TERMINAL</p> |  |  |  <p>NS 140 00</p> |
| <p>BMC MODEL</p> <p>NS 141 00/1 - TERMINAL</p> |  |  |  <p>NS 141 00</p> |
| <p>FORD CARGO</p>  <p>NS 142 01</p> |  |  |  <p>NS 142 01</p> |
| <p>KARSAN</p> <p>NS 144 00/1 - TERMINAL</p> |  |  |  <p>NS 144 00</p> |

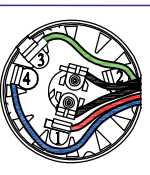
FAR VE SİNYAL ANAHTARLARI

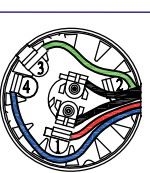
HEADLIGHT AND SIGNAL SWITCHES

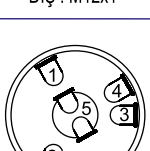
SCHEINNERFERSCHATERN

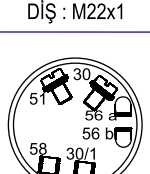

| | | | | |
|-----------|---|--|---|--|
| NS 108 00 |  |  <p>Diş : M12x1</p> | <p>1 FEED 2 SIDE/TAIL PANEL 3 DIP 4 MAIN BEAM 5 HORN</p> <p>1 2 3</p> <p>⇌ ⇐ PUSH KNOB FOR HORN</p> | <p>LUCAS - 33714 34592</p> <p>(240/285/255/265) MASSEY FERGUSON CASE IH DAVID BROWN</p> <p>KORNALI</p> |
| NS 108 02 |  |  <p>Diş : M12x1</p> | <p>1 FEED 2 SIDE/TAIL PANEL 3 DIP 4 MAIN BEAM 5 HORN</p> <p>1 2 3</p> <p>⇌ ⇐ PUSH KNOB FOR HORN</p> | <p>LUCAS - 33714 34592</p> <p>MASSEY FERGUSON CASE IH DAVID BROWN</p> |
| NS 108 04 |  |  <p>Diş : M12x1</p> | <p>1 FEED 2 SIDE/TAIL 4 MAIN BEAM 3 DIP</p> <p>0 1 2 3</p> | <p>(35X) MASSEY FERGUSON CASE IH DAVID BROWN</p> |
| NS 108 12 |  |  <p>Diş : M12x1</p> | <p>1 FEED 2 SIDE/TAIL PANEL 3 DIP 4 MAIN BEAM 5 HORN 6 FEED</p> <p>1 2</p> <p>⇌ ⇐ PUSH KNOB FOR HORN</p> | <p>VALTRA (ACV010976A)</p> |
| NS 108 13 |  |  <p>Diş : M12x1</p> | <p>1 FEED 2 SIDE/TAIL PANEL 3 DIP 4 MAIN BEAM 5 HORN 6 FEED</p> <p>1 2 3</p> <p>⇌ ⇐ PUSH KNOB FOR HORN</p> | <p>VALTRA (ACV010977A)</p> |
| NS 108 14 |  |  <p>Diş : M12x1</p> | <p>1 FEED 2 SIDE/TAIL PANEL 3 DIP 4 MAIN BEAM 5 HORN 6 FEED</p> <p>1 2 3</p> <p>⇌ ⇐ PUSH KNOB FOR HORN</p> | <p>VALTRA (ACV001043A)</p> |
| NS 109 00 |  |  <p>Diş : M22x1</p> | <p>1 FEED 2 SIDE/TAIL 3 DIP 4 MAIN BEAM</p> <p>0 1 2 3 4</p> <p>⇌ ⇐ PUSH KNOB FOR HORN (5A max. 1 dak.)</p> | <p>(80.66/55.46) FIAT TRAKTÖR TÜMOSAN HATTAT YAĞMUR TARIM</p> |
| NS 109 02 |  |  <p>Diş : M22x1</p> | <p>1 FEED 2 SIDE/TAIL 3 DIP 4 MAIN BEAM</p> <p>0 1 2 3 4</p> <p>⇌ ⇐ PUSH KNOB FOR HORN (5A max. 1 dak.)</p> | <p>COBO - 23.108.000</p> <p>(240/266/3105) MASSEY FERGUSON (80.66/55.46) FIAT / NEW HOLLAND SAME / LAMBORGHINI</p> |
| NS 110 00 |  |  <p>Diş : M22x1</p> | <p>1 FEED 2 AUX 3 FEED 4 SIDE/TAIL 4 DIP 4 MAIN/BEAM</p> <p>0 1 2 3 4</p> <p>P</p> | <p>(450/480/640) FIAT TRAKTÖR LONG TRAKTÖR UNIVERSAL TRAKTÖR</p> |











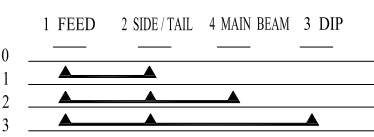
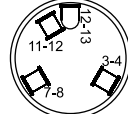

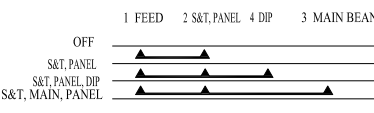
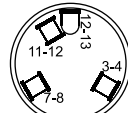

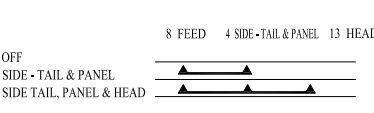
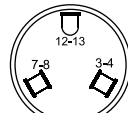

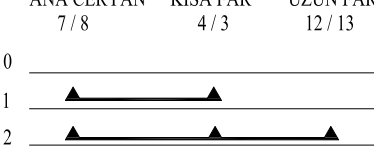
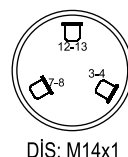

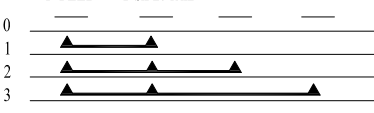

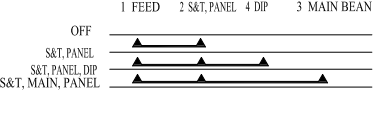
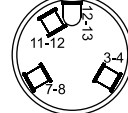
FAR VE SİNYAL ANAHTARLARI

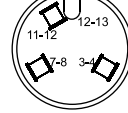
HEADLIGHT AND SIGNAL SWITCHES

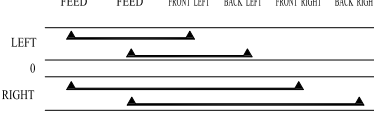
SCHEINNERFERSCHATERN



NESAN®

| | | | |
|--|--|---|---|
| (3000/5000/6600/6610) FORD / NEW HOLLAND | <p>1 FEED 2 SIDE/TAIL 4 MAIN BEAM 3 DIP</p> <p>0</p> <p>1</p> <p>2</p> <p>3</p>  |  <p>DİŞ: M14x1</p> |  <p>NS 111 00</p> |
| NEW HOLLAND | <p>1 FEED 2 S&T,PANEL 4 DIP 3 MAIN BEAM</p> <p>OFF</p> <p>S&T,PANEL</p> <p>S&T,PANEL,DIP</p> <p>S&T,MAIN,PANEL</p>  |  <p>DİŞ: M14x1</p> |  <p>NS 111 01</p> |
| NEW HOLLAND | <p>8 FEED 4 SIDE-TAIL & PANEL 13 HEAD</p> <p>OFF</p> <p>SIDE-TAIL & PANEL</p> <p>SIDE TAIL, PANEL & HEAD</p>  |  <p>DİŞ: M14x1</p> |  <p>NS 111 02</p> |
| BMC - FATİH/PRO BAŞAK | <p>ANA CERYAN 7 / 8 KISA FAR 4 / 3 UZUN FAR 12 / 13</p> <p>0</p> <p>1</p> <p>2</p>  |  <p>DİŞ: M14x1</p> |  <p>NS 111 04</p> |
| MASSEY FERGUSON FORD / NEW HOLLAND CASE IH DAVID BROWN | <p>1 FEED 2 SIDE/TAIL 4 MAIN BEAM 3 DIP</p> <p>0</p> <p>1</p> <p>2</p> <p>3</p>  |  <p>DİŞ: M14x1</p> |  <p>NS 111 06</p> |
| FORD / NEW HOLLAND | <p>1 FEED 2 S&T,PANEL 4 DIP 3 MAIN BEAM</p> <p>OFF</p> <p>S&T,PANEL</p> <p>S&T,PANEL,DIP</p> <p>S&T,MAIN,PANEL</p>  |  <p>DİŞ: M14x1</p> |  <p>NS 111 07</p> |
| MODİFİYE ARAÇLAR | <p>1 FEED 2 S&T,PANEL 4 DIP 3 MAIN BEAM</p> <p>OFF</p> <p>S&T,PANEL</p> <p>S&T,PANEL,DIP</p> <p>S&T,MAIN,PANEL</p>  |  <p>DİŞ: M14x1</p> |  <p>NS 111 08</p> |
| MASSEY FERGUSON(240/285) | <p>1 FEED 2 FEED 3 FRONT LEFT 4 BACK LEFT 5 FRONT RIGHT 6 BACK RIGHT</p> <p>LEFT</p> <p>0</p> <p>RIGHT</p>  |  <p>DİŞ: M14x1</p> |  <p>NS 112 00</p> |
| FIAT TRAKTÖR(450/480/640) HATTAT | <p>1 FEED 2 FEED 3 FRONT LEFT 4 BACK LEFT 5 FRONT RIGHT 6 BACK RIGHT</p> <p>LEFT</p> <p>0</p> <p>RIGHT</p>  |  <p>DİŞ: M14x1</p> |  <p>NS 113 00</p> |

FAR VE SİNYAL ANAHTARLARI

HEADLIGHT AND SIGNAL SWITCHES

SCHEINNERFERSCHATERN



| | | | | | |
|-----------|--|----------------|---|--------------------------|---|
| NS 165 00 | | DIŞ: M14x1 | 8A 8A 10A 1 2 A 3 | FORD CARGO (4C4611654AB) | FAR ANAHTARI HEADLIGHT SWITCH |
| NS 166 00 | | DIŞ: M14x1 | 1 2 3 | FORD CARGO | KALORİFER ANAHTARI HEATER SWITCH |
| NS 166 01 | | DIŞ: M14x1 | 1 2 3 | FORD CARGO | FAR ANAHTARI HEADLIGHT SWITCH |
| NS 167 00 | | DIŞ: M14x1 | 1 2 3 4 | OTOKAR | KALORİFER ANAHTARI HEATER SWITCH |
| NS 168 01 | | DIŞ: M14x1 | 1 A 3 | OTOKAR MAGIRUS | ARKA KALORİFER ANAHTARI HEATER SWITCH |
| NS 169 01 | | DIŞ: M14x1 | 1 2 3 4 | OTOKAR MAGIRUS | ÖN KALORİFER ANAHTARI HEATER SWITCH |
| NS 170 00 | | DIŞ: M14x1 | 1 2 3 | BMC | KALORİFER ANAHTARI HEATER SWITCH |
| NS 191 00 | | | ELEKTRİK DEVRESİ / ELECTRICAL CIRCUIT | HELLA - 001 561-001 | (240/285) MASSEY FERGUSON TÜMOSAN BAŞAK NATO |

**NS 185 00****NS 186 01****NS 186 00****NS 181 00****NS 180 01****NS 180 00****NS 190 00****NS 189 02****NS 189 01****NS 189 00****NS 187 00****NS 184 00****NS 183 00****NS 182 00**

HARARET VE FAN MÜŞİRLERİ

TEMPERATURE SWITCHES

TEMPERATURSCHALTERN













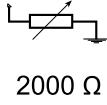



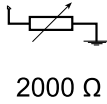



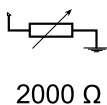



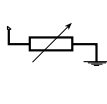



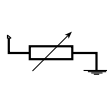



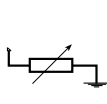



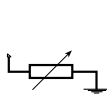



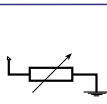

| | | | | | | |
|-----------|--|-------------|------|--------|-----------|---|
| NS 201 00 | | 1/8x27 NPTF | 16 | 500 Ω | 6,35x0,80 | FORD TRAKTÖR ₍₃₀₀₀₋₅₀₀₀₎ |
| NS 201 01 | | 1/8x27 NPTF | 16 | 2000 Ω | 6,35x0,80 | |
| NS 202 00 | | 1/8x27 NPTF | 8-13 | 500 Ω | 6,35x0,80 | FORD CARGO _(EM/YM 24.24-32.30) |
| NS 203 00 | | 1/8x27 NPTF | 19 | 2000 Ω | 6,35x0,80 | ISUZU |
| NS 204 00 | | M14x1,5 | 19 | 2000 Ω | 6,35x0,80 | STEYR / BAŞAK ₍₇₆₈₎ |
| NS 204 01 | | M14x1,5 | 19 | 2000 Ω | 6,35x0,80 | STEYR / BAŞAK |
| NS 205 00 | | M22x1,5 | 27 | 2000 Ω | 6,35x0,80 | FIAT / NEW HOLLAND _(450/80.66) TÜMOSAN FORD FINIS LAMBORGHINI TRACTOR |
| NS 206 00 | | 5/8x18 UNF | 19 | 1000 Ω | 6,35x0,80 | BMC _(TM30-L60-TDI80) |
| NS 206 01 | | 5/8x18 UNF | 19 | 500 Ω | 6,35x0,80 | BMC _(PRO) |
| NS 206 02 | | 5/8x18 UNF | 19 | 500 Ω | 6,35x0,80 | BMC _(TM30-L60-TDI80) ROVER |

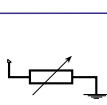
**NESAN®**

HARARET VE FAN MÜŞİRLERİ

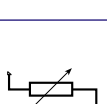
TEMPERATURE SWITCHES

TEMPERATURSCHALTERN

| | | | | | | |
|--|--|--|--|--|---|------------------|
| (135/285)MASSEY FERGUSON CASE IH DAVID BROWN LANDINI |  6,35x0,80 |  2000 Ω |  19 |  5/8x18 UNF |  | NS 207 00 |
| (135/285)MASSEY FERGUSON CASE IH DAVID BROWN LANDINI |  6,35x0,80 |  2000 Ω |  19 |  5/8x18 UNF |  | NS 207 01 |
| (3600/6600/6610)FORD / NEW HOLLAND |  6,35x0,80 |  2000 Ω |  19 |  3/8x18 NPTF |  | NS 208 00 |
| FORD / NEW HOLLAND |  M5 |  500 Ω |  8-19 |  3/8x18 NPTF |  | NS 208 01 |
| FIAT / NEW HOLLAND TÜMOSAN FORD FINIS LAMBORGHINI TRACTOR |  6,35x0,80 |  2000 Ω |  27 |  M22x1,5 |  | NS 212 00 |
| FIAT TRAKTÖR |  6,35x0,8 |  2000 Ω |  27 |  M22x1,5 |  | NS 212 01 |
| INTER TRAKTÖR |  6,35x0,80 |  500 Ω |  19 |  M14x1,5 |  | NS 214 00 |
| CASE IIIH BEDFORD |  6,35x0,80 |  2000 Ω |  22 |  1/2x14 NPTF |  | NS 215 00 |
| ROVER |  6,35x0,80 |  2000 Ω |  19 |  M16x1 |  | NS 216 00 |
| (NPR-CHAMPION)ISUZU |  6,35x0,80 |  500 Ω |  19 |  M16x1,5 |  | NS 218 00 |

HARARET VE FAN MÜŞİRLERİ











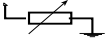



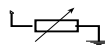

TEMPERATURE SWITCHES

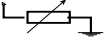
TEMPERATURSCHALTERN

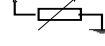

NESAN[®]

| | | | | | | |
|-----------|--|-----------------|----------|------------|---------------|--|
| NS 220 00 | | 1/8x27 NPTF | 8-13 | 500 Ω | M 5 | ANADOL |
| NS 221 00 | | 1/8x27 NPTF | 13 | 2000 Ω | Ø4 | ROVER |
| NS 222 00 | | M18x1,5 | 22 | 2000 Ω | 6,35x0,80 | HATTAT |
| NS 223 00 | | 1/2x14 NPTF | 22 | 2000 Ω | 6,35x0,80 | MASSEY FERGUSON _(395G/260G/266G) CASE IH JOHN DEERE HATTAT |
| NS 223 01 | | 1/2x14 NPTF | 22 | 500 Ω | 6,35x0,80 | JOHN DEERE |
| NS 224 00 | | 1/8x27 NPTF | 13 | 500 Ω | 6,35x0,80 | FORD / NEW HOLLAND ₍₃₀₀₀₋₅₀₀₀₎ ASKAM _(AS600-AS250) |
| NS 226 00 | | 1/2x14 NPTF | 8-22 | 500 Ω | M 5 | JCB |
| NS 226 01 | | 1/2x14 NPTF | 22 | 500 Ω | 6,35x0,80 | CASE IH |
| NS 250 01 | | M16x1,5 | 19 | 2000 Ω | 6,35x0,80 | KOMATSU |
| NS 250 02 | | M16x1,5 | 19 | 500 Ω | 6,35x0,80 | (FH220) HITACHI |

| | | | | | | |
|--------------------------------|--|--|--|--|--|------------------|
| (L2.5-L3.0-L100) BMC |  6,35x0,80 |  500 Ω |  13 |  M12x1,25 |  | NS 252 00 |
| (EM/YM 24.24-32.30) FORD CARGO |  6,35x0,80 |  2000 Ω |  13 |  1/8x27 NPTF |  | NS 254 00 |
| ROVER OPEL |  6,35x0,80 |  500 Ω |  16 |  5/8x18 UNF |  | NS 255 00 |
| |  |  |  22 |  M12x1,5 |  | NS 265 03 |









































YAĞ BASINÇ MÜŞİRLERİ

OIL PRESSURE SWITCHES

ÖLDRUCKSCHALTERN



| | | | | | | | |
|-----------|--|-----------------|--------|-------------------|---------------|--|---|
| NS 301 00 | | 1/8x27 NPTF | 24 | 0,40-0,70 bar | 6,35x0,80 | BMC ISUZU VOLVO OTOKAR CASE IH MASSEY FERGUSON ^(135/240/285) | PERKINS - 3.152, 4.236, 6.354, PHASER 1000 series LUCAS - SOB103 FAE - 11420 13280 13335 |
| NS 301 01 | | 1/8x27 NPTF | 22 | 0,20-0,50 bar | 6,35x0,80 | VW - GOLF-JETTA | |
| NS 301 02 | | 1/8x27 NPTF | 24 | 1,00 bar | 6,35x0,80 | JOHN DEERE | |
| NS 302 00 | | M12x1,5 | 24 | 0,30-0,60 bar | 6,35x0,80 | TÜMOSAN CASE IH FIAT / NEW HOLLAND ^(480/640/80.66) FORD TRAKTÖR DEUTZ FAHR IVECO ^(50NC) | |
| NS 302 01 | | M12x1,5 | 21 | 0,20-0,40 bar | 6,35x0,80 | TÜMOSAN CASE IH FIAT / NEW HOLLAND FORD TRAKTÖR DEUTZ FAHR IVECO ^(50NC) | |
| NS 303 00 | | 1/4x18 NPTF | 24 | 0,20-0,50 bar | 6,35x0,80 | MASSEY FERGUSON CASE IH FORD TRAKTÖR ^(3000/5000) ROVER SAAB | |
| NS 304 00 | | M10x1 | 24 | 0,20-0,50 bar | 6,35x0,80 | AUDI SEAT VW VOLVO SKODA | |
| NS 304 01 | | M10x1 | 24 | 0,20-0,50 bar | 6,35x0,80 | CASE IH FORD FINIS FENDT ALFA ROMEO VW BMW | BOSCH - 0 986 344 082 0 986 344 085 HELLA - 6ZL 003 259 391 |
| NS 304 02 | | M10x1 | 24 | 0,40-0,60 bar | 6,35x0,80 | STEYR / BAŞAK ⁽⁷⁶⁸⁾ MASSEY FERGUSON AUDI | BOSCH - 0 986 344 058 |
| NS 305 00 | | M10x1 | 24 | 0,40-0,70 bar | 6,35x0,80 | ROVER FORD NATO | |

| | | | | | | | |
|--|--|---|---|--|--|---|------------------|
| ROVER |  6,35x0,80 |  0,50 bar |  24 |  1/2x20 UNF |  | NS 307 00 | |
| RENAULT SAAB SEAT (J9)PEUGEOT HATTAT | ALFA ROMEO CITROEN DACIA FIAT LADA OPEL |  6,35x0,80 |  0,20-0,50 bar |  24 |  M14x1 5 |  | NS 309 00 |
| (206-306-405-505-605)PEUGEOT (FELICIA)SKODA CITROEN ROVER |  6,35x0,80 |  0,20-0,50 bar |  24 |  M16x1,5 |  | NS 311 01 | |
| CASE IH DAVID BROWN SUZUKI TOYOTA |  6,35x0,80 |  0,20-0,50 bar |  24 |  1/8x28 BSP |  | NS 318 00 | |
| (L2.5-L3.0-L100)BMC ISUZU |  6,35x0,80 |  0,40-0,60 bar |  24 |  1/8x28 BSP |  | NS 319 00 | |
| (MEGASTAR)BMC |  6,35x0,80 |  0,30-0,60 bar |  24 |  1/8x27 NPTF |  | NS 324 00 | |
| CASE IH FORD / NEW HOLLAND ROVER |  M 4 |  0,50 bar |  8-24 |  1/8x27 NPTF |  | NS 325 00 | |
| CASE IH FORD / NEW HOLLAND |  6,35x0,80 |  0,50 bar |  24 |  1/8x27 NPTF |  | NS 330 00 | |

İKAZ MÜŞİRLERİ











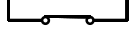









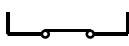



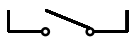



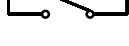









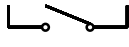



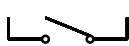

WARNING SWITCHES

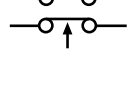
WARNUNGSSCHALTERN

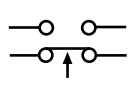

NESAN®

| | | | | | | | |
|-----------|--|------------|-------|--|-----------|--|---|
| NS 401 00 | | M10x1,5 | 17 | | 6,35x0,80 | FORD / NEW HOLLAND | AYAK FREN MÜŞİRİ FOOT BRAKE SWITCH |
| NS 406 00 | | 3/8x16 UNC | 19 | | Ø4 | BMC (TM30-L1.8) | GERİ VİTES MÜŞİRİ REVERSE GEAR SWITCH |
| NS 406 01 | | 3/8x16 UNC | 16-19 | | Ø4 | BMC (FATİH 280 - PRO) | KEP İKAZ MÜŞİRİ CAB WARNING SWITCH |
| NS 406 02 | | 3/8x16 UNC | 19 | | 6,35x0,80 | OTOKAR ROVER | LUCAS - SMB 485 GERİ VİTES MÜŞİRİ GEARBOX SWITCH |
| NS 407 00 | | 3/4x16 UNF | 33 | | 6,35x0,80 | MASSEY FERGUSON(240/285) FORD / NEW HOLLAND(3000/3600) | VİTES OTOMATIĞI GEARBOX SWITCH |
| NS 407 01 | | 3/4x16 UNF | 33 | | 6,35x0,80 | FORD / NEW HOLLAND CASE / NEW HOLLAND FORD FINIS | LUCAS - SMB 484 VİTES EMNİYET MÜŞİRİ GEARBOX SAFETY SWITCH |
| NS 408 00 | | 3/4x16 UNF | 27 | | 6,35x0,80 | MASSEY FERGUSON(260/277/285/398/398T/3105) JCB | KUYRUK MİL - VİTES EMNİYET MÜŞİRİ GEARBOX SAFETY SWITCH |
| NS 408 01 | | 3/4x16 UNF | 27 | | 6,35x0,80 | MASSEY FERGUSON(260/277/285/398/398T/3105) JCB | KUYRUK MİL - VİTES EMNİYET MÜŞİRİ GEARBOX SAFETY SWITCH |
| NS 409 00 | | M16x1,5 | 27 | | 6,35x0,80 | MASSEY FERGUSON(240/255/260/266G/398/3105) YAĞMUR TARIM | HİDROSTATİK DİREKSİYON-AYAK FREN MÜŞİRİ STEERING WHEEL-FOOT BRAKE SWITCH |
| NS 409 01 | | M16x1,5 | 24-27 | | 6,35x0,80 | TÜMOSAN | PARK FREN İKAZ MÜŞİRİ PARKING BRAKE WARNING SWITCH |

| | | | | | | | |
|---|---|--|--|---|---|---|-----------|
| FREN MÜŞİRİ BRAKE SWITCH | NEW HOLLAND VALTRA HATTAT VOLVO |  6,35x0,80 |  |  27-17 |  M12x1 |  | NS 409 02 |
| EL FREN İKAZ MÜŞİRİ HAND BRAKE WARNING SWITCH | (240/266/3060/3105)MASSEY FERGUSON |  6,35x0,80 |  |  27-22 |  M16x1,5 |  | NS 410 00 |
| KEP İKAZ MÜŞİRİ CAB WARNING SWITCH | (FATİH(F180 HARIÇ)-PRO)BMC |  6,35x0,80 |  |  22-22 |  M14x1,5 |  | NS 413 00 |
| LUCAS - SMB 499 VİTES EMNİYET MÜŞİRİ GEARBOX SAFETY SWITCH | CASE IH TALBOT ROVER |  6,35x0,80 |  |  33 |  M16x2 |  | NS 414 00 |
| GERİ VİTES MÜŞİRİ REVERSE GEAR SWITCH | (FATİH)BMC FORD CARGO ASKAM / DODGE |  6,35x0,80 |  |  33-24 |  M16x2 |  | NS 415 00 |
| GERİ VİTES MÜŞİRİ REVERSE GEAR SWITCH | (FATİH)BMC ROVER |  6,35x0,80 |  |  33 |  M16x2 |  | NS 415 01 |
| GERİ VİTES MÜŞİRİ REVERSE GEAR SWITCH | FIAT TRAKTÖR HATTAT |  M 6 |  |  32 |  M16x1,5 |  | NS 416 00 |
| MARŞ EMNİYET ŞALTERİ - VİTES EMNİYET MÜŞİRİ GEAR SAFETY SWITCH | STEYR / BAŞAK TÜMÖSAN |  M 6 |  |  22-32 |  M16x1,5 |  | NS 416 01 |
| PTO EMNİYET MÜŞİRİ PTO SWITCH | (240S/255EP/260/3105)MASSEY FERGUSON |  |  |  27 |  3/4x16 UNF |  | NS 417 00 |
| PTO EMNİYET MÜŞİRİ PTO SWITCH | (3050/3060)MASSEY FERGUSON |  |  |  27 |  3/4x16 UNF |  | NS 417 01 |











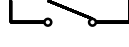



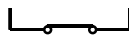



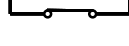



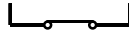



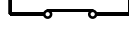



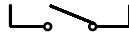



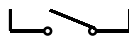



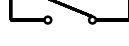

İKAZ MÜŞİRLERİ

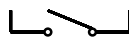
WARNING SWITCHES

WARNUNGSSCHALTERN

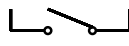

| | | | | | | | |
|-----------|--|-------------|-------|--|-----------|---|--|
| NS 418 00 | | M14x1,5 | 22-27 | | | BMC (L3.0) | KABIN İKAZ MÜŞİRİ CAB WARNING SWITCH |
| NS 418 01 | | M12x1 | 27 | | | BMC (MEGASTAR360-340) | GERİ VİTES MÜŞİRİ CAB WARNING SWITCH |
| NS 418 03 | | M14x1,5 | 22-27 | | 6,35x0,8 | YAĞMUR TARIM | İKAZ MÜŞİRİ WARNING SWITCH |
| NS 419 01 | | | | | 6,35x0,80 | ASKAM / DODGE / FARGO ROVER - DEFENDER AUDI / SEAT / VW | HELLA 6ZF 05 388-001 KAPI İŞIK BUTONU DOOR LOCK WARNING SWITCH |
| NS 419 02 | | | | | 6,35x0,80 | BMC | KAPI İÇ AYDINLATMA BUTONU DOOR LOCK WARNING SWITCH |
| NS 419 05 | | | | | 6,35x0,80 | BMC HATTAT | KAPI İÇ AYDINLATMA BUTONU DOOR LOCK WARNING SWITCH |
| NS 419 06 | | | | | 6,35x0,80 | UNIVERSAL | KAPI İÇ AYDINLATMA BUTONU DOOR LOCK WARNING SWITCH |
| NS 419 07 | | | | | 6,35x0,80 | KARSAN | KAPI İÇ AYDINLATMA BUTONU DOOR LOCK WARNING SWITCH |
| NS 420 00 | | 9/16X18 UNF | 22-22 | | 6,35x0,80 | ASKAM / DODGE / FARGO | FREN STOP LAMBASI MÜŞİRİ BRAKE LIGHT SWITCH |

| | | | | | | |
|--|--|--|---|---|---|------------------|
| (260/276G/286G/398/3105)MASSEY FERGUSON |  6,35x0,80 |  |  22 |  3/4X16 UNF |  | NS 423 00 |
| DİFERANSİYEL KİLİT İKAZ MÜŞİRİ GEAR LOCK WARNING SWITCH | | | | | | |
| (260/3060/3105)MASSEY FERGUSON |  6,35x0,80 |  |  27 |  M16x1,5 |  | NS 424 00 |
| SHUTTLE ŞANZİMAN VİTES MÜŞİRİ GEARBOX SWITCH | | | | | | |
| HATTAT HİDROMEK KARSAN |  6,35x0,80 |  |  22-27 |  M16X1,5 |  | NS 425 00 |
| FREN İKAZ MÜŞİRİ BRAKE WARNING SWITCH | | | | | | |
| TEMSA |  6,35x0,80 |  |  22-27 |  M16X1,5 |  | NS 425 01 |
| STEPNE İKAZ MÜŞİRİ SPARE TYRE LOCK SWITCH | | | | | | |
| |  6,35x0,80 |  |  22-27 |  M16X1,5 |  | NS 425 03 |
| DAMPER KALDIRMA İKAZ MÜŞİRİ DUMP RAISING WARNING SWITCH | | | | | | |
| (55.46/80.66)FIAT TRAKTÖR KARSAN YAĞMUR TARIM |  6,35x0,80 |  |  22 |  M14x1,5 |  | NS 429 00 |
| MARŞ EMNİYET MÜŞİRİ- KABİN İKAZ MÜŞİRİ IGNITION SAFETY-CAB WARNING SWITCH | | | | | | |
| FIAT / NEW HOLLAND KARSAN IVECO |  6,35x0,80 |  |  22 |  M14x1,5 |  | NS 429 01 |
| MARŞ EMNİYET MÜŞİRİ- KABİN İKAZ MÜŞİRİ IGNITION SAFETY-CAB WARNING SWITCH | | | | | | |
| (110/90)FIAT / NEW HOLLAND FORD FINIS |  6,35x0,80 |  |  22 |  M14x1,5 |  | NS 430 00 |
| DEBRİYAJ EMNİYET MÜŞİRİ CLUTCH SAFETY SWITCH | | | | | | |
| TÜMOSAN |  6,35x0,80 |  |  22 |  M14x1,5 |  | NS 430 03 |
| DİFERANSİYEL EMNİYET MÜŞİRİ GEARBOX SAFETY SWITCH | | | | | | |
| OTOKAR |  6,35x0,80 |  |  22 |  M14x1,5 |  | NS 430 04 |
| DEBRİYAJ EMNİYET MÜŞİRİ GEARBOX SAFETY SWITCH | | | | | | |

İKAZ MÜŞİRLERİ

















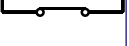



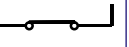



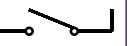



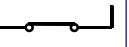









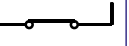



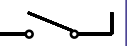



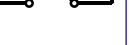

WARNING SWITCHES

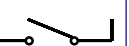
WARNUNGSSCHALTERN



NESAN®

| | | | | | | | | |
|-----------|--|---------------|----|--|--|-----------|--|--|
| NS 432 00 | | M14x1,5 | 22 | | | 6,35x0,80 | BMC (L60-MEGASTAR) | DEBRİYAJ EMNİYET MÜŞİRİ GEARBOX SAFETY SWITCH |
| NS 432 01 | | M14x1,5 | 22 | | | 6,35x0,80 | BMC (MEGASTAR) | DEBRİYAJ MÜŞİRİ GEARBOX SAFETY SWITCH |
| NS 433 01 | | M16x1,5 | 24 | | | 6,35x0,80 | FORD | AYAK FREN MÜŞİRİ FOOT BRAKE SWITCH |
| NS 435 00 | | M10x1,5 | 17 | | | Ø4 | TOYOTA DAIHATSU HONDA ISUZU MITSUBISHI | FAE - 25060 25080 KONTAK ANAHTARI EMNİYET MÜŞİRİ IGNITION SAFETY SWITCH |
| NS 436 00 | | M6 | | | | 6,35x0,80 | MASSEY FERGUSON (X35) | AYAK FREN MÜŞİRİ FOOT BRAKE SWITCH |
| NS 437 00 | | M12x1,5 | 19 | | | 6,35x0,80 | FIAT IVECO LADA SEAT SKODA ALFA ROMEO | LUCAS - SMB 428 FREN MÜŞİRİ BRAKE SWITCH |
| NS 438 00 | | M16x2 | 33 | | | M 6 | MASSEY FERGUSON (TE 20 DIESEL) | VİTES OTOMATİĞİ GEARBOX SWITCH |
| NS 441 00 | | M27X1-M18X1,5 | 27 | | | Ø4 | BMC MERCEDES MAN HINO SCANIA | ZF - 0501313916 0501311818 FAE - 41120 GERİ VİTES MÜŞİRİ REVERSE GEAR SWITCH |
| NS 441 03 | | M27X1-M18X1,5 | 27 | | | Ø4 | AKA OTOMOTİV FORD | GERİ VİTES MÜŞİRİ REVERSE GEAR SWITCH |
| NS 442 00 | | M27X1-M18X1,5 | 27 | | | Ø4 | BMC MERCEDES MAN IVECO PAGASO | ZF - 0501311807 0501207847 0501203994 FAE - 40420 GERİ VİTES MÜŞİRİ REVERSE GEAR SWITCH |

| | | | | | | | |
|--|--|--|--|--|--|---|------------------|
| GERİ VİTES MÜŞİRİ REVERSE GEAR SWITCH | MERCEDES ERA |  27 |  |  Ø4 |  M27X1-M20X1,5 |  | NS 443 00 |
| TDS - F18.043 FAE - 41130 | MERCEDES |  27 |  |  Ø4 |  M27X1-M16X1,5 |  | NS 444 00 |
| GERİ VİTES MÜŞİRİ REVERSE GEAR SWITCH | BMC MERCEDES IVECO SCANIA ERA |  Ø4 |  |  27 |  M27X1-M18X1,5 |  | NS 445 00 |
| GERİ VİTES MÜŞİRİ REVERSE GEAR SWITCH | BMC MOTOR IBERICA |  Ø4 |  |  27 |  M27X1-M18X1,5 |  | NS 445 01 |
| ZF - 0501311809 6S85 ŞANZIMAN FAE - 40690 | MERCEDES |  Ø4 |  |  27 |  M27X1-M12X1 |  | NS 446 00 |
| FAE - 25100 | MERCEDES |  Ø4 |  |  27 |  M27X1-M16X1,5 |  | NS 447 00 |
| GERİ VİTES MÜŞİRİ REVERSE GEAR SWITCH | (FATİH INTERCOOL) BMC FORD CARGO (AS950) ASKAM MERCEDES |  Ø4 |  |  27 |  M27X1-M12X1,5 |  | NS 448 00 |
| GERİ VİTES MÜŞİRİ REVERSE GEAR SWITCH | SCANIA |  Ø4 |  |  27 |  M27X1-M12X1,5 |  | NS 448 01 |
| GERİ VİTES MÜŞİRİ REVERSE GEAR SWITCH | SCANIA |  Ø4 |  |  27 |  M27X1-9/16X8 UNF |  | NS 449 00 |
| GERİ VİTES MÜŞİRİ REVERSE GEAR SWITCH | FORD MERCEDES MAN IVECO STEYR PEGASO |  Ø4 |  |  27 |  M27X1-M18X1,5 |  | NS 450 00 |
| ZF - 0501311607 0501203944 0501311807 9S75 ŞANZ. FAE - 40440 | BMC MERCEDES MAN SCANIA HINO STEYR |  Ø4 |  |  27 |  M27X1-M18X1,5 |  | NS 450 00 |

İKAZ MÜŞİRLERİ

WARNING SWITCHES











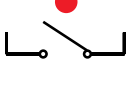



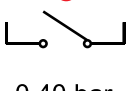



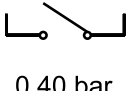



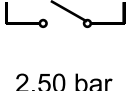



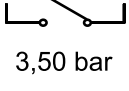



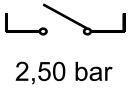



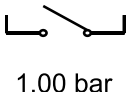



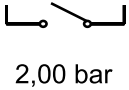

WARNUNGSSCHALTERN

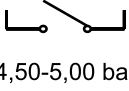

NESAN®

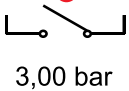
| | | | | | | | |
|-----------|--|---------------|----|--|--|---|---|
| NS 453 00 | | 27X1 - 30X1,5 | 36 | | | MERCEDES VW | GERİ VİTES MÜŞİRİ REVERSE GEAR SWITCH |
| NS 460 00 | | M18X1,5 | 27 | | | BMC FORD CARGO MERCEDES SCANIA VOLVO ERA | ZF - 0501216474 9S109 ŞANZ. FAE - 41301 GERİ VİTES MÜŞİRİ REVERSE GEAR SWITCH |
| NS 460 01 | | M18X1,5 | 27 | | | MERCEDES | GERİ VİTES MÜŞİRİ REVERSE GEAR SWITCH |
| NS 460 03 | | M26x1,5 | 27 | | | FORD CARGO | EGZOZ AYAK FREN MÜŞİRİ PEDAL BRAKE SWITCH |
| NS 461 00 | | M18X1,5 | 27 | | | BMC FORD CARGO MERCEDES SCANIA VOLVO | GERİ VİTES MÜŞİRİ REVERSE GEAR SWITCH |
| NS 462 00 | | M20X1,5 | 27 | | | MERCEDES MAN | FAE - 41300 GERİ VİTES MÜŞİRİ REVERSE GEAR SWITCH |
| NS 601 00 | | | 24 | | | MASSEY FERGUSON | FREN ŞALTERİ BRAKE SWITCH |
| NS 601 01 | | | 24 | | | HATTAT | FREN ŞALTERİ BRAKE SWITCH |
| NS 603 00 | | | 24 | | | FIAT / NEW HOLLAND | FREN ŞALTERİ BRAKE SWITCH |
| NS 603 01 | | | 24 | | | FIAT / NEW HOLLAND CLAAS | FREN ŞALTERİ BRAKE SWITCH |
| NS 603 03 | | | 24 | | | STEYR / BAŞAK | EL FREN OTOMATİĞİ HAND BRAKE SWITCH |
| NS 604 00 | | | 24 | | | FIAT / NEW HOLLAND | EL FREN MÜŞİRİ-TERS HAND BRAKE SWITCH |

**NESAN®****BASINÇ MÜŞİRLERİ
PRESSURE SWITCHES
DRUCKSCHALTERN**

| | | | | | | | | |
|---|--|--|---|--|--|--|--|------------------|
| WABCO - 4410140190 | (FATİH-PRO)BMC MERCEDES MAN DAF |  6,35x0,80 |  0,15 bar |  24 |  M12x1,5 |  | NS 523 00 | |
| FREN MÜŞİRİ (HAVA BASINÇ) AIR PRESSURE - BRAKE SWITCH | | | | | | | | |
| GÖNDERGE MOTOR ZAMAN SAATİ AIR PRESSURE SWITCH | (FATİH/F270)BMC |  6,35x0,80 |  0,40 bar |  24 |  1/8x27 NPTF |  | NS 523 01 | |
| STOP LAMBA MÜŞİRİ (HAVA BASINÇ) AIR PRESSURE SWITCH | DAF VOLVO SCANIA STEYR | (PROBUS)BMC IVECO MAN MERCEDES RENAULT NEOPLAN |  6,35x0,80 |  0,40 bar |  24 |  M12x1,5 |  | NS 523 02 |
| WABCO - 4410140010 | MERCEDES MAN NEOPLAN LIEBHERR | OTOKAR / DEUTZ IVECO DAF VOLVO RENAULT EVOBUS |  6,35x0,80 |  2,50 bar |  24 |  M12x1,5 |  | NS 523 03 |
| KAPI İKAZ MÜŞİRİ (HAVA BASINÇ) AIR PRESSURE- DOOR WARNING SWITCH | | | | | | | | |
| YAĞ BASINÇ MÜŞİRİ OIL PRESSURE SWITCH | TÜMOSAN |  6,35x0,80 |  3,50 bar |  24 |  1/8x27 NPTF |  | NS 523 04 | |
| HAVA BASINÇ MÜŞİRİ AIR PRESSURE SWITCH | (BELDE)BMC |  6,35x0,80 |  2,50 bar |  24 |  M12x1,5 |  | NS 523 09 | |
| YAĞ BASINÇ MÜŞİRİ (FREN MÜŞİRİ) BRAKE - OIL PRESSURE SWITCH | (TD Serisi)NEW HOLLAND |  6,35x0,80 |  1,00 bar |  24 |  1/8x27 NPTF |  | NS 523 13 | |
| WABCO - 4410140050 | IVECO / OTOYOL MAN NEOPLAN RENAULT VOLVO |  6,35x0,80 |  2,00 bar |  24 |  M10x1 |  | NS 523 17 | |
| KAPI İKAZ MÜŞİRİ (HAVA BASINÇ) AIR PRESSURE SWITCH | | | | | | | | |
| FREN BASINÇ MÜŞİRİ (YAĞ BASINÇ) OIL-BRAKE PRESSURE SWITCH | (J9 (EM)-PREMIER)PEUGEOT MASTAŞ |  6,35x0,80 |  4,50-5,00 bar |  24 |  M10x1 |  | NS 523 18 | |
| WABCO - 4410140400 | BMC ISUZU |  6,35x0,80 |  3,00 bar |  24 |  M12x1,5 |  | NS 523 22 | |
| KAPI VE FREN MÜŞİRİ (HAVA BASINÇ) AIR-BRAKE PRESSURE SWITCH | | | | | | | | |

BASINÇ MÜŞİRLERİ











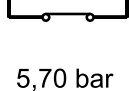



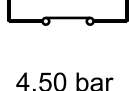



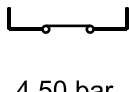













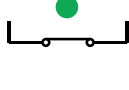



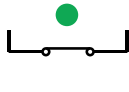



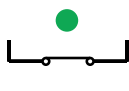

PRESSURE SWITCHES

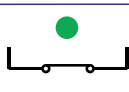
DRUCKSCHALTERN

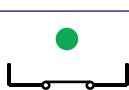

| | | | | | | | |
|-----------|--|-------------|--|--------------|---------------|--|---|
| NS 523 24 | | 1/8x27 NPTF | | 4,50 bar | 6,35x0,80 | JOHN DEERE | FREN BASINÇ MÜŞİRİ (YAĞ BASINÇ) OIL-BRAKE PRESSURE SWITCH |
| NS 523 25 | | M10x1 | | 0,50 bar | 6,35x0,80 | WABCO (660301-E) SANKO | FREN BASINÇ MÜŞİRİ (YAĞ BASINÇ) OIL-BRAKE PRESSURE SWITCH |
| NS 523 30 | | M10x1 | | 0,15 bar | 6,35x0,80 | TEMSA | FREN BASINÇ MÜŞİRİ (HAVA BASINÇ) AIR-BRAKE PRESSURE SWITCH |
| NS 523 31 | | M10x1 | | 0,30 bar | 6,35x0,80 | TEMSA | FREN BASINÇ MÜŞİRİ (HAVA BASINÇ) AIR-BRAKE PRESSURE SWITCH |
| NS 523 32 | | M10x1 | | 0,50 bar | 6,35x0,80 | TEMSA | FREN BASINÇ MÜŞİRİ (HAVA BASINÇ) AIR-BRAKE PRESSURE SWITCH |
| NS 524 00 | | M12x1,5 | | 5,50 bar | 6,35x0,80 | BMC(FATİH/PRO827/OTOBÜS) MERCEDES MAN DAF IVECO | DÜŞÜK BASINÇ MÜŞİRİ (HAVA BASINÇ) AIR PRESSURE SWITCH |
| NS 524 01 | | M12x1,5 | | 5,50 bar | 6,35x0,80 | BMC(FATİH/F180/PRO /BELDE(EM)) DAF IVECO MAN NEOPLAN WABCO (0140040441) | HAVA BASINÇ MÜŞİRİ AIR PRESSURE SWITCH |
| NS 524 02 | | M12x1,5 | | 3,00 bar | 6,35x0,80 | ISUZU IVECO NEOPLAN BOMAŞ/GÜLERYÜZ SCANIA VOLVO | HAVA BASINÇ MÜŞİRİ AIR PRESSURE SWITCH |
| NS 524 03 | | M16x1,5 | | 5,50 bar | 6,35x0,80 | BMC (FATİH/PRO624/827/OTOBÜS) | HAVA İKAZ LAMBA MÜŞİRİ AIR LOW PRESSURE SWITCH |
| NS 524 04 | | M12x1,5 | | 0,60 bar | 6,35x0,80 | BMC IVECO NEW HOLLAND | HİDROLİK DİREKSİYON YAĞ BASINÇ MÜŞİRİ STEERING WHEEL OIL PRESSURE SWITCH |

**NESAN®****BASINÇ MÜŞİRLERİ**
PRESSURE SWITCHES
DRUCKSCHALTERN

| | | | | | | | |
|--|--|--|---|--|--|---|------------------|
| WABCO - 4110140140 | ASKAM / DODGE / FARGO |  6,35x0,80 |  5,70 bar |  24 |  1/4x18 NPTF |  | NS 524 07 |
| HAVA BASINÇ MÜŞİRİ AIR PRESSURE SWITCH | | | | | | | |
| WABCO - 4410141010 | FORD CARGO OTOKAR MAGIRUS MAN EVOBUS SCANIA VOLVO |  6,35x0,80 |  4,50 bar |  24 |  M12x1,5 |  | NS 524 08 |
| HAVA BASINÇ MÜŞİRİ (İMDAT-İKAZ) AIR PRESSURE SWITCH | | | | | | | |
| WABCO - 4410140120 | (BELDE)BMC DAF |  6,35x0,80 |  4,50 bar |  24 |  M12x1,5 |  | NS 524 09 |
| EL FİREN İMDAT MÜŞİRİ EMERGENCY SWITCH | | | | | | | |
| WABCO - 4110140150 | FORD CARGO DAF NEOPLAN MERCEDES |  6,35x0,80 |  3,50 bar |  24 |  M12x1,5 |  | NS 524 12 |
| HAVA BASINÇ MÜŞİRİ AIR PRESSURE SWITCH | | | | | | | |
| ISUZU SCANIA VOLVO | ISUZU MERCEDES MAN DAF RENAULT IVECO |  6,35x0,80 |  5,00 bar |  24 |  M12x1,5 |  | NS 524 13 |
| HAVA BASINÇ MÜŞİRİ AIR PRESSURE SWITCH | | | | | | | |
| WABCO - 4410140250 | (FATİH/F180/PRO /BELDE(EM))BMC DAF IVECO MAN NEOPLAN |  6,35x0,80 |  5,50 bar |  24 |  M12x1,5 |  | NS 524 14 |
| HAVA BASINÇ MÜŞİRİ AIR PRESSURE SWITCH | | | | | | | |
| MAN NEOPLAN SCANIA | ISUZU OTOYOL IVECO MERCEDES VOLVO DAF RENAULT |  6,35x0,80 |  6,00 bar |  24 |  M12x1,5 |  | NS 524 15 |
| HAVA BASINÇ MÜŞİRİ AIR PRESSURE SWITCH | | | | | | | |
| | BMC (PRO1144) |  6,35x0,80 |  0,20 bar |  24 |  M12x1,5 |  | NS 524 21 |
| HAVA BASINÇ MÜŞİRİ AIR PRESSURE SWITCH | | | | | | | |
| | HATTAT VALTRA |  6,35x0,80 |  5,50 bar |  24 |  M12x1,5 |  | NS 524 23 |
| HAVA BASINÇ MÜŞİRİ AIR PRESSURE SWITCH | | | | | | | |
| | (255/265/285)MASSEY FERGUSON |  6,35x0,80 |  13,78 bar |  24 |  1/8x27 NPTF |  | NS 528 00 |
| YÜKSEK BASINÇ / KUYRUK MİL MÜŞİRİ (YAĞ BASINÇ) HIGH PRESSURE SWITCH | | | | | | | |

BASINÇ MÜŞİRLERİ

PRESSURE SWITCHES

DRUCKSCHALTERN













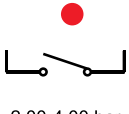



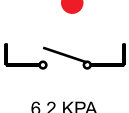



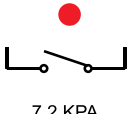

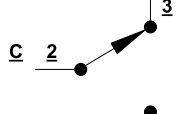

| | | | | | | | |
|-----------|--|-------------|----|---------------|-----------|--|--|
| NS 528 02 | | M10x1 | 24 | 14,00 bar | 6,35x0,80 | HATTAT | BASINÇ MÜŞİRİ (YAĞ BASINÇ) OIL PRESSURE SWITCH |
| NS 533 00 | | 1/8x27 NPTF | 27 | 3,00-3,60 bar | 6,35x0,80 | MASSEY FERGUSON (266/276/285/398/398T/3105) | HİDROLİK DİREKSİYON MÜŞİRİ HYDRAULIC STEERING WHEEL SWITCH |
| NS 534 01 | | M12x1,5 | 24 | 5,70 bar | Ø4 | KARSAN OTOBÜS | HİDROLİK DİREKSİYON MÜŞİRİ HYDRAULIC STEERING WHEEL SWITCH |
| NS 535 00 | | 1/8x27 NPTF | 24 | 4,80-5,50 bar | 6,35x0,80 | FORD CARGO | EL FREN İKAZ/BEYİN ANA MERKEZ/HAVA İKAZ MÜŞİRİ HAND BRAKE WARNING SWITCH |
| NS 537 00 | | M12x1,5 | 27 | 0,20-0,50 bar | | FORD CARGO | HAVA FREN BEYİN İKAZ MÜŞİRİ BRAKE CENTER SWITCH |
| NS 537 01 | | M12x1,5 | 27 | 0,20-0,50 bar | | FORD CARGO | HAVA FREN BEYİN İKAZ MÜŞİRİ BRAKE CENTER SWITCH |
| NS 537 06 | | M12x1,5 | 27 | 5,50 bar | | MERCEDES (ACTROS/ATEGO/AXOR) | EL FREN İMDAT MÜŞİRİ (HAVA BASINÇ) AIR PRESSURE-HAND BRAKE SWITCH |
| NS 537 07 | | M12x1,5 | 27 | 6,50 bar | | MERCEDES (ACTROS/ATEGO/AXOR) | EL FREN İMDAT MÜŞİRİ (HAVA BASINÇ) AIR PRESSURE-HAND BRAKE SWITCH |
| NS 551 00 | | M10x1 | 24 | 2,00-4,00 bar | 6,35x0,80 | MERCEDES MAN RENAULT IVECO KASSBOHRER BERU | BOSCH - 0986345112 YAĞ BASINÇ MÜŞİRİ OIL PRESSURE SWITCH |
| NS 551 01 | | M10x1 | 24 | 3,00-6,00 bar | 6,35x0,80 | MERCEDES MAN DAF OTOKAR MAGIRUS VOLVO CATERPILLAR | BOSCH - 0986345110 0344004018 YAĞ BASINÇ MÜŞİRİ OIL PRESSURE SWITCH |

**NESAN®**

BASINÇ MÜŞİRLERİ

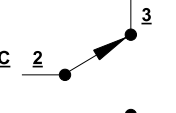
PRESSURE SWITCHES

DRUCKSCHALTERN

| | | | | | | |
|--|--|---|---|--|---|--|
| <p>FAE - 21060</p> <p>FREN MÜŞİRİ (YAĞ MÜŞİRİ) OIL PRESSURE-BRAKE SWITCH</p> | <p>(L3.0)BMC (J9)PEUGEOT TALBOT</p> |  6,35x0,80 |  2,00-4,00 bar |  24 |  7/16X20 UNF |  NS 551 03 |
| <p>(255/255T/260/398/398T)MASSEY FERGUSON</p> <p>VAKUM MÜŞİRİ (HAVA TOZ FİLTRE MÜŞİRİ) AIR VACUUM SWITCH</p> | <p>(255/255T/260/398/398T)MASSEY FERGUSON</p> |  6,35x0,80 |  6,2 KPA |  24 |  1/8x27 NPTF |  NS 561 62 |
| <p>(3050/3060)MASSEY FERGUSON</p> <p>VAKUM MÜŞİRİ (HAVA TOZ FİLTRE MÜŞİRİ) AIR VACUUM SWITCH</p> | <p>(3050/3060)MASSEY FERGUSON</p> |  6,35x0,80 |  7,2 KPA |  24 |  1/8x27 NPTF |  NS 561 72 |
| <p>FORD CARGO - AC46 19H354 AA WABCO - 441 044 102 0</p> <p>PRESSURE SENSOR</p> | | <p>12 Bar</p> |  |  M16x1,5 |  NE 4500 00 | |
| <p>PRESSURE SWITCH</p> | <p>NORMALLY OPEN : 1 COMMON : 2 NORMALLY CLOSE : 3</p> |  0,20-0,50 Bar |  |  M18x1,5 |  NE 4501 00 | |
| <p>REVERSE GEAR SWITCH</p> | <p>NORMALLY OPEN : 1 COMMON : 2 NORMALLY CLOSE : 3</p> |  0,20-0,50 Bar |  |  M18x1,5 |  NE 4501 01 | |

DEVRE KESİCİLER

BATTERY MASTER SWITCHES

BATTERIE HAUPTSCHALTERN



NS 650 05

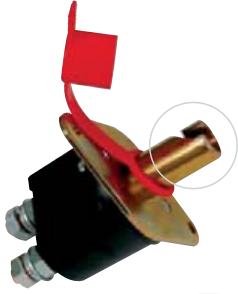

M10x1,5

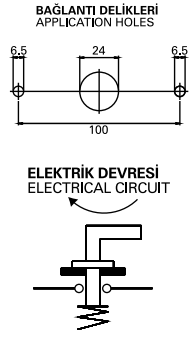

ASKAM
BMC
CLAAS
DAF
FAUN
FIAT - IVECO
HANOMAG
INTER HARVESTER
ISUZU
JOHN DEERE
KASSBOHRER
KRONE
LIEBHERR
MAGIRUS DEUTZ
MAN
MASSEY FERGUSON
MASTAŞ / SANKO
MERCEDES
NATO
NEOPLAN
O&K
RENAULT
SCANIA
STEYR
VOLVO

BOSCH 0341 002 002
0341 002 003
COBO 13.002.000
HELLA 6EK 001 559 001
6EK 001 559 007
6EK 001 559 011
EK 001 559 031
LUCAS SSB111

NS 650 06



M10x1,5

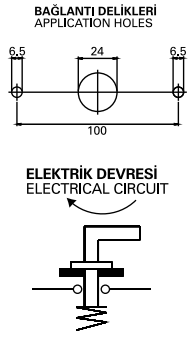

BMC
OTOKAR / MAGIRUS
OTOYOL / IVECO
ROVER
MAN



Çalışma Akımı : 250A
Max. Akım : 2500Ax5Sec
Nominal Voltaj : 12 / 24V
Çalışma Sıcaklığı : -40/ +85°C

NS 651 00



M10x1,5

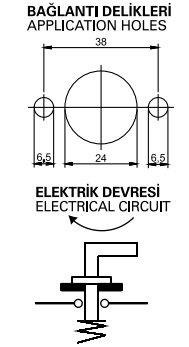

OTOKAR / MAGIRUS
MERCEDES
VOLVO
JOHN DEERE



Çalışma Akımı : 100A
Max. Akım : 500Ax5Sec
Nominal Voltaj : 12 / 24V
Çalışma Sıcaklığı : -40/ +85°C

NS 652 00



M10x1,5

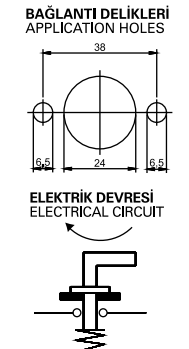

FORD CARGO



Çalışma Akımı : 100A
Max. Akım : 500Ax5Sec
Nominal Voltaj : 12 / 24V
Çalışma Sıcaklığı : -40/ +85°C







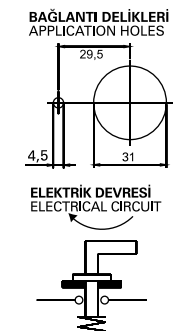



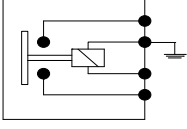
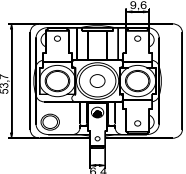

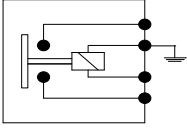
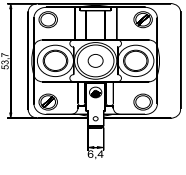

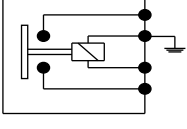
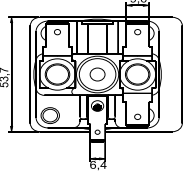

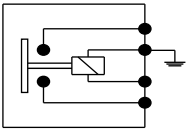
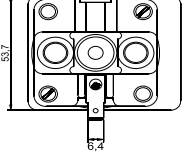
NS 655 00

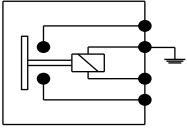
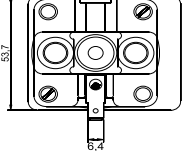

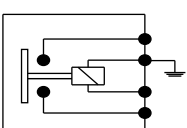
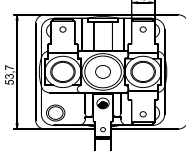
M10x1,5

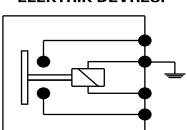
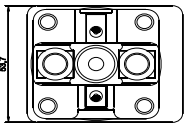

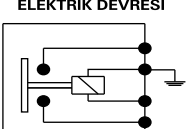
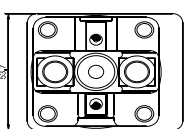









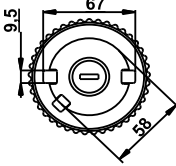

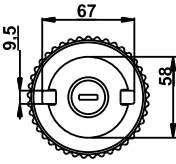

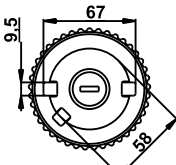

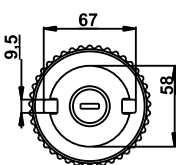
Çalışma Akımı : 250A
Max. Akım : 2500Ax5Sec
Nominal Voltaj : 12 / 24V
Çalışma Sıcaklığı : -40/ +85°C

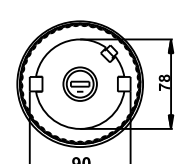
| | | | | |
|--|---|---|---|------------------|
| <p>LUCAS - SRB346 (FATİH/PRO/OTOBÜS)BMC</p> <p>Çalışma Akımı : Min.30A Max. Akım : 250A Nominal Voltaj : 24V Çalışma Sıcaklığı : -40/ +100°C</p> | <p>ELEKTRİK DEVRESİ</p>  |  |  | <p>NS 720 00</p> |
| <p>LUCAS - SRB346 (FATİH/PRO/OTOBÜS)BMC</p> <p>Çalışma Akımı : Min.30A Max. Akım : 250A Nominal Voltaj : 24V Çalışma Sıcaklığı : -40/ +100°C</p> | <p>ELEKTRİK DEVRESİ</p>  |  |  | <p>NS 720 01</p> |
| <p>LUCAS - SRB325 (TM30/L2.5/L3.0/L60)BMC 76464-76766-76722 (TRANSIT)FORD NATO CASE IH FORD / NEW HOLLAND</p> <p>Çalışma Akımı : Min.60A Max. Akım : 250A Nominal Voltaj : 12V Çalışma Sıcaklığı : -40/ +100°C</p> | <p>ELEKTRİK DEVRESİ</p>  |  |  | <p>NS 721 00</p> |
| <p>LUCAS - SRB325 (TM30/L2.5/L3.0/L60)BMC (TRANSIT)FORD NATO CASE IH FORD / NEW HOLLAND</p> <p>Çalışma Akımı : Min.60A Max. Akım : 250A Nominal Voltaj : 12V Çalışma Sıcaklığı : -40/ +100°C</p> | <p>ELEKTRİK DEVRESİ</p>  |  |  | <p>NS 721 01</p> |
| <p>MASTAŞ / SANKO</p> <p>Çalışma Akımı : Min.30A Max. Akım : 250A Nominal Voltaj : 12V Çalışma Sıcaklığı : -40/ +100°C</p> | <p>ELEKTRİK DEVRESİ</p>  |  |  | <p>NS 721 02</p> |
| <p>LUCAS - SRB333 (CAPRI/ESCORT/FIESTA/TRANSIT)FORD</p> <p>Çalışma Akımı : Min.30A Max. Akım : 250A Nominal Voltaj : 12V Çalışma Sıcaklığı : -40/ +100°C</p> | <p>ELEKTRİK DEVRESİ</p>  |  |  | <p>NS 721 03</p> |
| <p>(OTOBÜS)BMC (ŞAHİN BAKIŞ/2520/YM)FORD CARGO</p> <p>Çalışma Akımı : Min.30A Max. Akım : 250A Nominal Voltaj : 24V Çalışma Sıcaklığı : -40/ +100°C</p> | <p>ELEKTRİK DEVRESİ</p>  |  |  | <p>NS 722 00</p> |
| <p>FORD CARGO YM</p> <p>Çalışma Akımı : Min.30A Max. Akım : 250A Nominal Voltaj : 24V Çalışma Sıcaklığı : -40/ +100°C</p> | <p>ELEKTRİK DEVRESİ</p>  |  |  | <p>NS 722 01</p> |

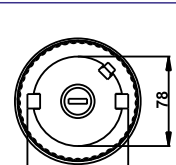
DEPO KAPAKLARI

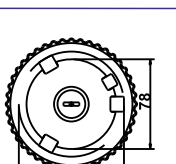
FUEL TANK CAPS

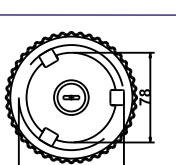
TANKDECKELN

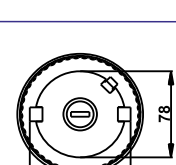
| | | | | | | |
|------------------|---|---|--|--|--|---|
| NS 803 00 |  |  | Boğaz Çapı : 60mm Bağlantı : 2 Tırnaklı Ventilsiz Paslanmaz Çelik Kilitli | FORD CARGO (EM) VOLVO DAF SCANIA OTOYOL / IVECO MAN | JOHN DEERE STEYR / BAŞAK CASE IH FORD TRAKTÖR CNH DEUTZ | FENDT FIAT TRAKTÖR NEW HOLLAND SAME DF ISUZU TRUCK VOLVO 220 |
| NS 803 01 |  |  | Boğaz Çapı : 60mm Bağlantı : 2 Tırnaklı Ventilsiz Paslanmaz Çelik Kilitsiz | FORD CARGO (EM) VOLVO DAF SCANIA OTOYOL / IVECO MAN | JOHN DEERE STEYR / BAŞAK CASE IH FORD TRAKTÖR CNH DEUTZ | FENDT FIAT TRAKTÖR NEW HOLLAND SAME DF ISUZU TRUCK VOLVO 220 |
| NS 803 02 |  |  | Boğaz Çapı : 60mm Bağlantı : 2 Tırnaklı Ventilsiz Çinko Kaplama Kilitli | FORD CARGO (EM) VOLVO DAF SCANIA OTOYOL / IVECO MAN | JOHN DEERE STEYR / BAŞAK CASE IH FORD TRAKTÖR CNH DEUTZ | FENDT FIAT TRAKTÖR NEW HOLLAND SAME DF ISUZU TRUCK VOLVO 220 |
| NS 803 03 |  |  | Boğaz Çapı : 60mm Bağlantı : 2 Tırnaklı Ventilsiz Çinko Kaplama Kilitsiz | FORD CARGO (EM) VOLVO DAF SCANIA OTOYOL / IVECO MAN | JOHN DEERE STEYR / BAŞAK CASE IH FORD TRAKTÖR CNH DEUTZ | FENDT FIAT TRAKTÖR NEW HOLLAND SAME DF ISUZU TRUCK VOLVO 220 |
| NS 804 00 |  |  | Boğaz Çapı : 80mm Bağlantı : 2 Tırnaklı Ventilsiz Elektrostatik boyalı Kilitli | BMC - FATİH(EM) MERCEDES AXOR ATEGO ACTROS MAN | IVECO DAF VOLVO BMC - FATİH (EM) SCANIA JOHN DEERE | |
| NS 811 00 |  |  | Boğaz Çapı : 80mm Bağlantı : 2 Tırnaklı Ventilsiz Paslanmaz çelik Kilitli | BMC FORD MERCEDES MAN RENAULT SCANIA | VOLVO DAF IVECO CLAAS CATERPILLAR DEUTZ | FENDT JOHN DEERE AXOR ATEGO ACTROS |
| NS 811 02 |  |  | Boğaz Çapı : 80mm Bağlantı : 3 Tırnaklı Ventilsiz Paslanmaz çelik Kilitli | VOLVO SCANIA DAF HINO BEKO MITSUBISHI | | |
| NS 811 03 |  |  | Boğaz Çapı : 80mm Bağlantı : 3 Tırnaklı Ventilsiz Paslanmaz çelik Kilitsiz | VOLVO SCANIA DAF HINO BEKO MITSUBISHI | | |
| NS 814 00 |  |  | Boğaz Çapı : 80mm Bağlantı : 2 Tırnaklı Ventilsiz Çinko kaplama Kilitli | BMC FORD MERCEDES MAN RENAULT SCANIA | VOLVO DAF IVECO CLAAS CATERPILLAR DEUTZ | FENDT JOHN DEERE AXOR ATEGO ACTROS |



| | | | | | | |
|---|---|--|--|--|--|------------------|
| BMC FORD MERCEDES MAN RENAULT SCANIA | VOLVO DAF IVECO CLAAS CATERPILLAR DEUTZ | FENDT JOHN DEERE AXOR ATEGO ACTROS | Boğaz Çapı : 80mm Bağlantı : 2 Tırnaklı Ventilsiz Çinko kaplama Kilitsiz | | | NS 814 01 |
| | | DAF HINO VOLVO SCANIA BEKO MITSUBISHI | Boğaz Çapı : 80mm Bağlantı : 3 Tırnaklı Ventilsiz Çinko kaplama Kilitli | | | NS 814 02 |
| | | DAF HINO VOLVO SCANIA BEKO MITSUBISHI | Boğaz Çapı : 80mm Bağlantı : 3 Tırnaklı Ventilsiz Çinko kaplama Kilitsiz | | | NS 814 03 |
| | (TM30-L60-1.8-2.5-3.0)BMC | | Boğaz Çapı : 40mm Bağlantı : 2 Tırnaklı Ventilsiz Plastik/Metal gövde Kilitli | | | NS 820 00 |
| | (L3.0-L60-TDİ80-L100- FATİH 110 (EM))BMC HYUNDAI FORKLIFT KIA | | Boğaz Çapı : 40mm Bağlantı : 2 Tırnaklı Ventilsiz Plastik/Metal gövde Kilitli | | | NS 821 00 |
| | (L3.0-L60-TDİ80-L100-PRO 583-MEGASTAR-OTOBÜS)BMC | | Boğaz Çapı : 40mm Bağlantı : 2 Tırnaklı Sızdırmaz, güvenlik Valfli depolar için Plastik/Metal gövde Kilitli | | | NS 821 01 |
| | (50NC)IVECO DAILY HYUNDAI FORKLIFT | | Boğaz Çapı : 40mm Bağlantı : 2 Tırnaklı Ventilsiz Plastik/Metal gövde Kilitli | | | NS 821 04 |
| | MASSEY FERGUSON ŞAHSUVAROĞLU SAME | | Boğaz Çapı : 40mm Bağlantı : 2 Tırnaklı Ventilsiz Plastik/Metal gövde Kilitli | | | NS 821 05 |
| | (FATİH) BMC UNIVERSAL | | Boğaz Çapı : 40mm Bağlantı : 2 Tırnaklı Ventilsiz Plastik/Metal gövde Kilitli | | | NS 821 06 |

DEPO KAPAKLARI

FUEL TANK CAPS
TANKDECKELN



| | | | | | |
|------------------|--|--|---|--|---|
| NS 822 00 | | | Boğaz Çapı : 60mm Bağlantı : 2 Tırnaklı Ventilsiz Plastik, Metal Gövde Kilitli | HİDROMEK MASTAŞ / SANKO ÇUKUROVA LAND ROVER IVECO VOLVO | DAF SCANIA FORD JHON DEERE ISUZU TRUCK |
| NS 822 01 | | | Boğaz Çapı : 60mm Bağlantı : 2 Tırnaklı Ventilsiz Sızdırmaz, güvenlik Valfli depolar için | HİDROMEK MASTAŞ / SANKO ÇUKUROVA LAND ROVER IVECO VOLVO | DAF SCANIA FORD JHON DEERE ISUZU TRUCK BMC (FATİH/PRO) |
| NS 823 00 | | | Boğaz Çapı : 45mm Bağlantı : 2 Tırnaklı Ventilsiz Plastik metal gövde | FIAT TRAKTÖR LONG TRAKTÖR UNIVERSAL TRAKTÖR | |
| NS 824 00 | | | Boğaz Çapı : 45mm Bağlantı : 2 Tırnaklı Ventilsiz Plastik metal gövde | CASE IH FIAT TRAKTÖR | |
| NS 824 01 | | | Boğaz Çapı : 45mm Bağlantı : 2 Tırnaklı Ventilsiz Plastik metal gövde | BMC | |
| NS 826 00 | | | M60x2 Ventilsiz Plastik metal gövde Sızdırmaz | PEUGEOT (J9) OTOKAR (MAGIRUS/SULTAN) SANKO TOFAŞ (ŞAHİN/DOĞAN/KARTAL) | |
| NS 826 01 | | | M60x2 Ventilsiz Plastik metal gövde Sızdırmalı | TÜMOSAN (EM) | |
| NS 829 00 | | | Boğaz Çapı:48mm Bağlantı : 2 Tırnaklı Sızdırmaz, güvenlik Valfli depolar için Plastik metal gövde | MASSEY FERGUSON BMC- STEPNE KİLİDİ | |
| NS 830 00 | | | Boğaz Çapı:48mm Bağlantı : 2 Tırnaklı Sızdırmaz, güvenlik Valfli depolar için Plastik metal gövde | ISUZU (NDR66(2002>) / NKR) | |

**NESAN**[®]**DEPO KAPAKLARI****FUEL TANK CAPS****TANKDECKELN**











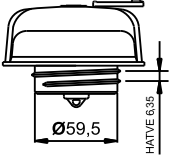

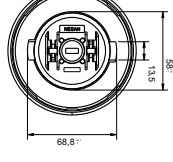

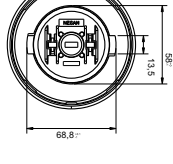

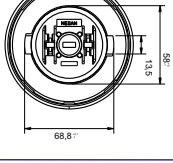
| | | | | | |
|---|---|--|--|------------------|------------------|
| (NPR 59-66(<2002) EM) ISUZU | Boğaz Çapı:48mm Bağlantı : 2 Tırnaklı Plastik metal gövde Sızdırmalı | | | NS 830 01 | |
| MASSEY FERGUSON LEYLAND TRAKTÖR NUFFIELD | Boğaz Çapı:63mm Bağlantı:DiştanKavramalı Ventilsiz Plastik Gövde | | | NS 834 00 | |
| IVECO DAILY 40-10 | FIAT / NEW HOLLAND FORD TRAKTÖR CASE IH DEUTZ SAME ŞAHSUVAROĞLU | Boğaz Çapı:80mm Bağlantı : Dişi paso Ventilli Plastik Kilitsiz | | | NS 835 00 |
| FIAT / NEW HOLLAND DEUTZ FAHR SAME ŞAHSUVAROĞLU TEMSA | Boğaz Çapı:60mm Bağlantı : Dişi paso Ventilli Plastik | | | NS 836 00 | |
| FIAT / NEW HOLLAND | M60x2 Ventilli Metal | | | NS 836 02 | |
| FORD CARGO UNIVERSAL | Boğaz Çapı:59,5mm 6 HATVELİ Bağlantı : Erkek paso Plastik | | | NS 837 18 | |
| FORD CARGO UNIVERSAL | Boğaz Çapı:59,5mm 6 HATVELİ Bağlantı : Erkek paso Plastik | | | NS 837 11 | |
| STEYR / BAŞAK SCANIA CLAAS JCB | MASSEY FERGUSON FORD / NEW HOLLAND JOHN DEERE CASE IH ERKUNT TÜMOSAN | Boğaz Çapı:59,5mm 6 HATVELİ Bağlantı : Erkek paso Ventilli Plastik | | | NS 837 12 |
| STEYR / BAŞAK SCANIA CLAAS JCB RENAULT | MASSEY FERGUSON FORD / NEW HOLLAND JOHN DEERE CASE IH ERKUNT TÜMOSAN | Boğaz Çapı:59,5mm 6 HATVELİ Bağlantı : Erkek paso Ventilli Plastik | | | NS 837 27 |

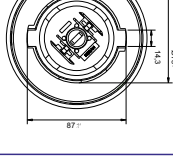
DEPO KAPAKLARI

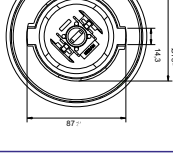
FUEL TANK CAPS

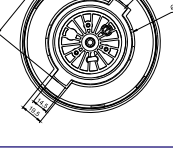
TANKDECKELN

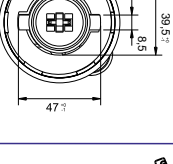

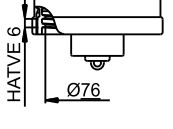
| | | | | | |
|-----------|---|---|--|---|--|
| NS 838 04 |  |  | Boğaz Çapı:59,5mm 6 HATVELİ Bağlantı : Erkek paso Ventilli Plastik | ASKAM / DODGE / HINO IVECO SCANIA FORD FINIS JOHN DEERE | VOLVO DAF |
| NS 839 05 |  |  | Boğaz Çapı:60mm Bağlantı : 2 Tırnaklı Ventilli Plastik | BMC IVECO (EUROCARGO) MERCEDES VOLVO LIEBHERR | SCANIA JOHN DEERE ÇUKUROVA FORD 403 TEMSA ISUZU TRUCK HIDROMEK MITSUBISHI |
| NS 843 05 |  |  | Boğaz Çapı:60mm Bağlantı : 2 Tırnaklı Ventilli Plastik | BMC IVECO (EUROCARGO) MERCEDES VOLVO LIEBHERR | SCANIA JOHN DEERE ÇUKUROVA FORD 403 TEMSA ISUZU TRUCK HIDROMEK MITSUBISHI |
| NS 843 12 |  |  | Boğaz Çapı:60mm Bağlantı : 2 Tırnaklı Ventilli Plastik | MASSEY FERGUSON | |
| NS 844 01 |  |  | Boğaz Çapı:80mm Bağlantı : 2 Tırnaklı Ventilli Plastik | BMC FORD CARGO IVECO (STRALIS) DAF MERCEDES MAN RENAULT | SCANIA TEMSA VOLVO SANKO SETRA CLAAS CASE IH AXOR ATEGO ACTROS DEUTZ FIAT TIR EUROSTAR EUROTECH |
| NS 844 04 |  |  | Boğaz Çapı:80mm Bağlantı : 2 Tırnaklı Ventilli Plastik | BMC FORD CARGO IVECO (STRALIS) DAF MERCEDES MAN RENAULT | SCANIA TEMSA VOLVO SANKO SETRA CLAAS CASE IH AXOR ATEGO ACTROS DEUTZ FIAT TIR EUROSTAR EUROTECH |
| NS 844 22 |  |  | Boğaz Çapı:80mm Bağlantı : 2 Tırnaklı Ventilli Plastik | BMC FORD CARGO IVECO (STRALIS) DAF MERCEDES MAN RENAULT | SCANIA TEMSA VOLVO SANKO SETRA CLAAS CASE IH AXOR ATEGO ACTROS DEUTZ FIAT TIR EUROSTAR EUROTECH |
| NS 845 00 |  |  | Boğaz Çapı:40mm Bağlantı : 2 Tırnaklı Ventilli Plastik | BMC ISUZU ÇUKUROVA | |
| NS 846 00 |  |  | Boğaz Çapı:80mm Bağlantı : Dişi paso Ventilli Plastik | CASE / NEW HOLLAND IVECO DAILY 40-10 | |



| | | | | | | | |
|--|--|---|------------------------------------|--|--|--|------------------|
| MERCEDES RENAULT VOLVO IVECO SCANIA FORD | Boğaz Çapı:60mm Bağlantı : 2 Tırnaklı Plastik | | | NS 847 02 | | | |
| HİDROMEK ERKUNT | Boğaz Çapı:59,5mm 6,35 Hatveli Bağlantı : Erkek paso Ventilli Plastik | | | NS 848 05 | | | |
| FIAT / NEW HOLLAND | Boğaz Çapı:60mm 5 Hatveli Bağlantı:Dişi Paso Ventilli Plastik | | | NS 849 00 | | | |
| ŞAHSUVAROĞLU | Boğaz Çapı: 6,2 Hatveli Bağlantı:Erkek Paso Ventilli Plastik Kilitsiz | | | NS 851 03 | | | |
| (H100)HYUNDAI KIA MITSUBİSHI ŞAHSUVAROĞLU LANDROVER DEFENTER | Boğaz Çapı: 6,2 Hatveli Bağlantı:Erkek Paso Ventilli Plastik Kilitli | | | NS 851 05 | | | |
| RENAULT HOWO-KOMATSU | Boğaz Çapı:90 mm Bağlantı:3 Tırnaklı Ventilli Plastik Kilit | | | NS 853 00 | | | |
| BMC FORD FORD CARGO DAF MERCEDES MAN RENAULT | SCANIA TEMSA VOLVO SANKO SETRA CLAAS CASE IH | AXOR ATEGO ACTROS IVECO DEUTZ FIAT T.I.R. STRALİS | EUROSTAR EUROTECH JOHN DEERE | Boğaz Çapı:80mm Bağlantı: 2 Tırnaklı Ventilli Plastik | | | NS 856 00 |
| BMC FORD FORD CARGO DAF MERCEDES MAN RENAULT | SCANIA TEMSA VOLVO SANKO SETRA CLAAS CASE IH | AXOR ATEGO ACTROS IVECO DEUTZ FIAT T.I.R. STRALİS | EUROSTAR EUROTECH JOHN DEERE | Boğaz Çapı:80mm Bağlantı: 2 Tırnaklı Ventilli Plastik | | | NS 858 00 |
| BMC KARSAN BELEDİYE OTOBÜSLERİ İÇİN | Bağlantı:Dişi Paso Metal | | | NS 865 00 | | | |

DEPO KAPAKLARI VE GÜVENKİK VALFLERİ











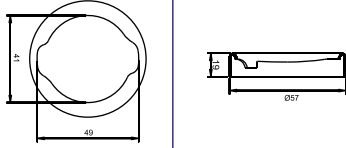

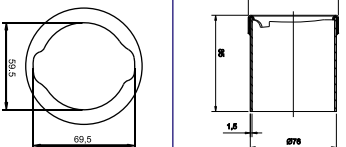

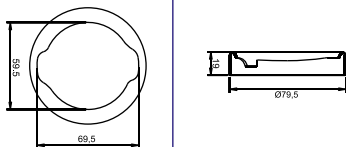

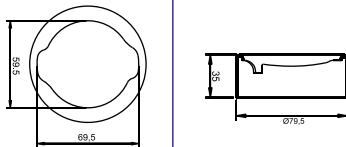

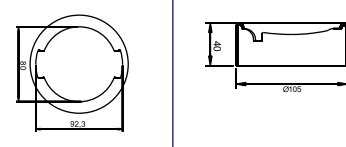

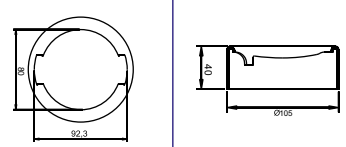
NESAN®

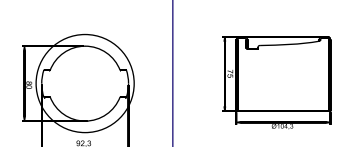
FUEL TANK CAPS and SAFETY VALVES

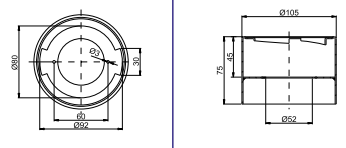
TANKDECKEL UND SICHERHEIT VENTILE

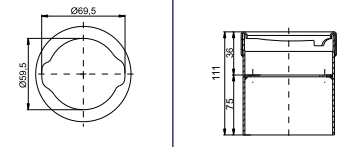
| | | | | |
|------------------|--|--|--|---|
| NS 866 01 | | | Boğaz Çapı:40mm Bağlantı : 2 Tırnaklı Ventilli Plastik Kilitsiz | MERCEDES MAN DAF SCANIA |
| NS 866 02 | | | Boğaz Çapı:40mm Bağlantı : 2 Tırnaklı Ventilsiz Plastik Kilitli | MERCEDES MAN SCANIA DAF |
| NS 866 03 | | | Boğaz Çapı:40mm Bağlantı : 2 Tırnaklı Ventilli | MERCEDES MAN SCANIA DAF |
| NS 708 00 | | | Bağlantı: 1/2 NPTF Yüksek Debili Açma Basıncı: 0,40 ^{+0.15} _{-0.05} Bar | YAKIT DEPOSU GÜVENLİK VALFİ FUEL TANKS SAFETY VALVE |
| NS 710 00 | | | Bağlantı: 1/2 NPTF Açma Basıncı: 0,60 ^{+0.30} _{-0.20} Bar | BMC ISUZU MASTAŞ ÇUKUROVA TEMSA OTOKAR YAKIT DEPOSU GÜVENLİK VALFİ FUEL TANKS SAFETY VALVE |
| NS 710 01 | | | Bağlantı: 1/2 NPTF Açma Basıncı: 0,60 ^{+0.30} _{-0.20} Bar | MASSEY FERGUSON YAKIT DEPOSU GÜVENLİK VALFİ FUEL TANKS SAFETY VALVE |
| NS 710 03 | | | Bağlantı: 1/2 NPTF Açma Basıncı: 0,30 ^{+0.15} _{-0.05} Bar | ISUZU YAKIT DEPOSU GÜVENLİK VALFİ FUEL TANKS SAFETY VALVE |

| | | | |
|-------------|--|---|-------------------|
| İç çap:40mm |  |  | NS 1027 02 |
| İç çap:60mm |  |  | NS 1028 00 |
| İç çap:60mm |  |  | NS 1028 02 |
| İç çap:60mm |  |  | NS 1028 03 |
| İç çap:80mm |  |  | NS 1029 10 |
| İç çap:80mm |  |  | NS 1029 12 |
| İç çap:80mm |  |  | NS 1029 15 |
| İç çap:80mm |  |  | NS 1029 16 |
| İç çap:60mm |  |  | NS 1034 03 |

DEPO BOĞAZLARI

FILLER NECKS

EINFÜLLSTUTZEN



| | | | | |
|------------|--|--|--|---|
| NS 1047 01 | | | | Hatve:6,35 Düz Tip Kaplmalı |
| NS 1047 06 | | | | Hatve:6,35 Etekli Tip Kaplmalı |
| NS 1047 22 | | | | Hatve:6,35 Etekli Tip Kaplmasız |
| NS 1059 00 | | | | Hatve:6,35 Etekli Tip Kaplmalı |
| NS 1064 02 | | | | |
| NS 1000 01 | | | | DEPO BOĞAZI YAKIT SÜZGEÇİ FUEL STRAINERS Çap:50,8mm |
| NS 1002 00 | | | | DEPO BOĞAZI YAKIT SÜZGEÇİ FUEL STRAINERS Çap:51mm |
| NS 1003 00 | | | | DEPO BOĞAZI YAKIT SÜZGEÇİ FUEL STRAINERS Çap:51mm |











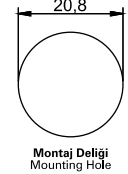
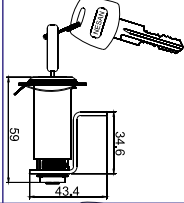

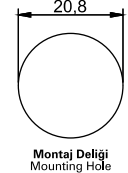
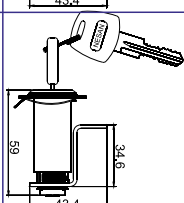

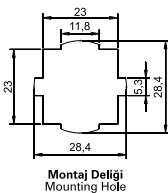
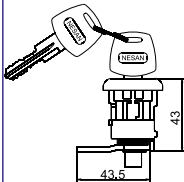

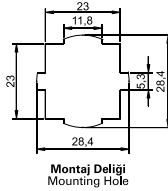
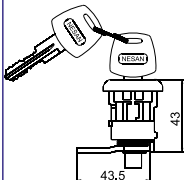

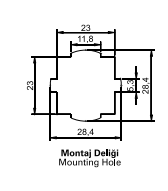
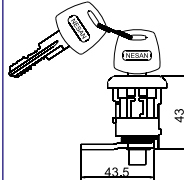
KAPI KİLİTLERİ

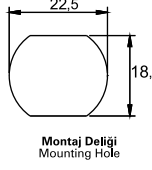
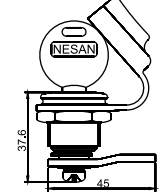
DOOR LOCKS

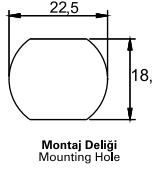
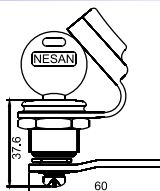
TÜRSCHLÖSSERN

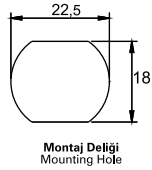
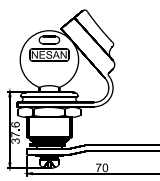

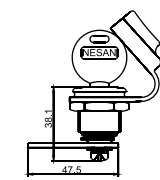
| | | | | | |
|-------------|--|--|--|------------------------------|---------|
| NS 902 00 | | | | BMC (L3.0 - PRO) ÇUKUROVA | SAĞ / R |
| NS 902 01 | | | | BMC (L3.0 - PRO) ÇUKUROVA | SOL / L |
| NS 902 00/1 | | | | BMC (MEGASTAR) | SAĞ / R |
| NS 908 00 | | | | BMC (L60/TDI80/L100) | SAĞ / R |
| NS 908 01 | | | | BMC (L60/TDI80/L100) | SOL / L |
| NS 909 00 | | | | BMC (FATİH) | SAĞ / R |
| NS 909 01 | | | | BMC (FATİH) | SOL / L |
| NS 912 00 | | | | BMC (FATİH YM) | SAĞ / R |
| NS 912 01 | | | | BMC (FATİH YM) | SOL / L |

| | | | | | |
|--|-----------------|--|---|---|------------------|
| SAĞ / R | (MEGASTAR)BMC |  20,8 Montaj Deliği Mounting Hole |  65 94,6 43,4 |  | NS 913 00 |
| SOL / L | (MEGASTAR)BMC |  20,8 Montaj Deliği Mounting Hole |  65 94,6 43,4 |  | NS 913 01 |
| SAĞ / R | FORD CARGO - YM |  23 11,8 28,4 23 5,3 28,4 Montaj Deliği Mounting Hole |  43 43,5 |  | NS 915 00 |
| SOL / L | FORD CARGO - YM |  23 11,8 28,4 23 5,3 28,4 Montaj Deliği Mounting Hole |  43 43,5 |  | NS 915 01 |
| SAĞ + SOL / R + L | FORD CARGO - YM |  23 11,8 28,4 23 5,3 28,4 Montaj Deliği Mounting Hole |  43 43,5 |  | NS B 2121 |
| Levyeye : 45 mm Latch: 45 mm Riegel: 45 mm | UNIVERSAL |  22,5 18,5 Montaj Deliği Mounting Hole |  37,6 45 |  | NS 920 01 |
| Levyeye : 60 mm Latch: 60 mm Riegel: 60 mm | UNIVERSAL |  22,5 18,5 Montaj Deliği Mounting Hole |  37,6 60 |  | NS 920 03 |
| Levyeye : 70 mm Latch: 70 mm Riegel: 70 mm | (OTOBÜS)BMC |  22,5 18,5 Montaj Deliği Mounting Hole |  37,6 70 |  | NS 920 04 |
| Levyeye : Kanca Tip Latch: Hook Type Riegel: Haken | MASTAŞ |  22,5 18,5 Montaj Deliği Mounting Hole |  38,4 47,5 |  | NS 920 05 |

KAPI KİLİTLERİ

DOOR LOCKS

TÜRSCHLÖSSERN



NESAN[®]

| | | | | |
|------------------|--|--|---------------------|--|
| NS 922 01 | | | BMC - OTOBÜS | Levye : 70 mm Latch: 70 mm Riegel: 70 mm |
| NS 922 02 | | | BMC | KAPORTA KİLİDİ BONNET LOCK |
| NS 922 07 | | | SANKO | |
| NS 925 01 | | | HIDROMEK | BAGAJ VE KAPUT KİLİDİ TRUNK AND HOOD LOCK |
| NS 925 04 | | | HIDROMEK | BAGAJ VE KAPUT KİLİDİ TRUNK AND HOOD LOCK |
| NS 926 02 | | | VALTRA (ACV0138280) | KAPUT KİLİDİ HOOD LOCK |
| NS 927 01 | | | VALTRA (ACV0188040) | KAPUT KİLİDİ HOOD LOCK |
| NS 930 00 | | | BMC (L60/FATİH/PRO) | TORPİDO KİLİDİ TOOLBOX LOCK |
| NS 931 00 | | | BMC (L60/FATİH/PRO) | TORPİDO KİLİDİ TOOLBOX LOCK |

**NESAN®**

KAPI KOLLARI

DOOR HANDLES

TÜRGRIFFE

| | | |
|---|---|---|
| BMC (PRO) TORBİDO KİLİDİ TOOLBOX LOCK |  <p>M18x1 AA27</p> |  <p>NS 934 00</p> |
| |  <p>(SOL - L) NS 945 01</p> |  <p>(SAĞ - R) NS 945 00</p> |
| MASSEY FERGUSON FIAT / NEW HOLLAND ERKUNT |  |  <p>NS 946 00</p> |
| MASSEY FERGUSON FIAT / NEW HOLLAND ERKUNT |  <p>(SOL - L) NS 948 01</p> |  <p>(SAĞ - R) NS 948 00</p> |
| KARSAN J10 |  <p>(SOL - L) NS 949 01</p> |  <p>(SAĞ - R) NS 949 00</p> |
| (FATİH)BMC | |  <p>NS 950 00</p> |
| (FATİH/PRO)BMC |  <p>(SOL - L) NS 951 01</p> |  <p>(SAĞ - R) NS 951 00</p> |
| (L3.0/L60/TDİ80L100)BMC |  <p>(SAĞ - R) NS 951 03</p> |  <p>(SOL - L) NS 951 02</p> |
| MERCEDES |  <p>Montaj Deliği Mounting Hole</p> |  <p>NS 953 00</p> |

KAPI KOLLARI

DOOR HANDLES

TÜRGRIFFE



| | | | |
|-----------|--|--|--|
| NS 954 00 | | | BMC _(TM30/FATİH 110) |
| NS 957 00 | | | BMC _(L1.8/L2.5/L3.0/L60/FATİH) |
| NS 958 00 | | | BMC _(L1.8/L2.5/L3.0/L60/TDİ80/L100/FATİH) |
| NS 958 01 | | | OTOKAR MAGIRUS |
| NS 959 00 | | | BMC _(L3.0/FATİH) (SAĞ-R) |
| NS 959 01 | | | BMC _(L3.0/FATİH) (SOL-L) |
| NS 960 00 | | | BMC _(L60/TDİ80/L100/MEGASTAR/PRO) (SAĞ-R) |
| NS 960 01 | | | BMC _(L60/TDİ80/L100/MEGASTAR/PRO) (SOL-L) |
| NS 961 00 | | | (L.2.5/L3.0/L60)BMC |



NESAN[®]

KAPI KOLLARI DOOR HANDLES TÜRGRIFFE

| | | | | |
|--|---|--|--|-----------|
| KAPI DIŞ KOLU DOOR HANDLE (OUTSIDE) | MERCEDES | | | NS 962 00 |
| KAPI DIŞ KOLU DOOR HANDLE (OUTSIDE) | UNIMOG | | | NS 964 00 |
| KAYAR KAPI DIŞ KOLU SLIDING DOOR HANDLE (OUTSIDE) | (MEGASTAR)BMC | | | NS 970 00 |
| ÖN KAPI DIŞ KOLU FRONT DOOR HANDLE (OUTSIDE) | (MEGASTAR)BMC | | | NS 971 00 |
| ARKA KAPI DIŞ KOLU BACK DOOR HANDLE (OUTSIDE) | (MEGASTAR)BMC | | | NS 972 00 |
| BAGAJ TUTAMAĞI TRUNK HANDLE | (OTOBÜS)BMC ISUZU TEMSA OTOYOL | | | NS 976 00 |
| KAPI / MOTOR KAPUT TUTAMAĞI BONNET HANDLE | | | | NS 978 00 |

SİNYAL VE SİLECEK KOLLARI

SIGNAL AND WIPER SWITCHES

SIGNALSCHALTERN UND WISCHERSCHALTERN



NESAN®

| | | | | |
|-----------|--|--|----------------|--|
| NS 194 00 | | BMC KARSAN | | SİNYAL KOLU SIGNAL SWITCH |
| NS 195 00 | | BMC KARSAN | | SİLECEK KOLU WIPER SWITCH |
| NS 194 04 | | BMC DAF VAN HOOL | VALEO - 201413 | SİNYAL VE SİLECEK KOLU SIGNAL AND WIPER SWITCH |
| NS 194 05 | | BMC FORD CARGO (9C4611K661AA) MERCEDES | VALEO - 202921 | SİNYAL VE SİLECEK KOLU SIGNAL AND WIPER SWITCH |
| NS 198 00 | | BMC | | RETARDER KOLU - 2 KADEME RETARDER SWITCH - 2 LEVELS |
| NS 198 01 | | BMC FORD CARGO (9C46202255AA) | | RETARDER KOLU - 5 KADEME RETARDER SWITCH - 5 LEVELS |



NESAN[®]

ASKERİ ÜRÜNLER MILITARY VEHICLE COMPONENTS MILITARFAHRZEUGKOMPONENTEN

BAĞLANTI YUVASI

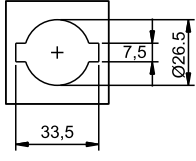

DEVRE ŞEMASI
ELECTRICAL CIRCUIT

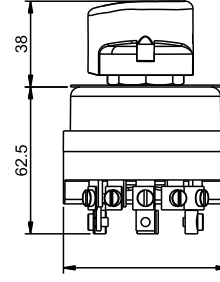
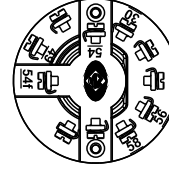
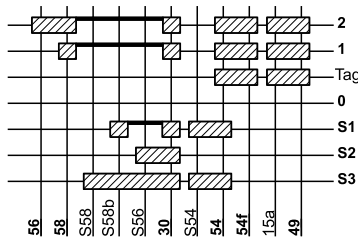

NS 130 00

KARARTMA ANAHTARI

BMC

İZ PLAKASI



NS 730 00

BMC

KAPI İÇ KOLU



(SAĞ / R)

NS 960 06



(SOL / L)

NS 960 07

ALFA ROMEO

| | | | | | | | |
|------------|----------|-----------|----------|------------|----------|------------|---------------|
| NS 3 09 00 | 510621 | NS 304 01 | 60506902 | NS 3 09 00 | 60593847 | NS 3 09 00 | 60807764 |
| NS 3 09 00 | 510893 | NS 304 02 | 60506902 | NS 3 04 01 | 60595694 | NS 3 04 01 | 10548063 2300 |
| NS 3 09 00 | 3100759 | NS 304 01 | 60593846 | NS 3 04 02 | 60595694 | NS 3 04 02 | 10548063 2300 |
| NS 3 09 00 | 60504190 | NS 304 02 | 60593846 | NS 4 37 00 | 60701852 | | |

ASKAM / DODGE

| | | | | | | | |
|------------|-------|-----------|-----------|------------|------------|------------|------------|
| NS 4 15 00 | 17030 | NS 650 05 | 33186 | NS 1 50 02 | 000A28322 | NS 5 24 07 | 000A39539T |
| NS 4 15 00 | 17030 | NS 420 00 | 1006335 9 | NS 4 19 01 | 000A31737 | NS 4 20 00 | 20933T |
| NS 4 47 00 | 18007 | NS 650 06 | 33186 | NS 4 19 01 | 000A31737 | NS 4 20 00 | 20933T |
| NS 8 38 04 | 28754 | NS 150 00 | 000A28322 | NS 4 20 00 | 000A34599T | NS 2 24 00 | 6854 07 |
| NS 8 38 04 | 28754 | NS 150 00 | 000A28322 | NS 4 20 00 | 000A34599T | NS 4 19 01 | PRC8548 |
| NS 4 19 01 | 31737 | NS 150 02 | 000A28322 | NS 5 24 07 | 000A39539T | NS 4 19 01 | PRC8548 |
| NS 4 19 01 | 31737 | | | | | | |

AUDİ

| | | | | | | | |
|------------|------------|-----------|-------------|------------|-------------|------------|-------------|
| NS 3 04 01 | 2191908 1 | NS 304 02 | 2691908 11 | NS 3 04 01 | 06191908 1B | NS 304 02 | 02191908 1C |
| NS 3 04 01 | 2891908 1 | NS 304 01 | 02191908 1A | NS 3 04 01 | 11191908 1A | NS 3 04 00 | 05691908 1B |
| NS 3 04 01 | 5991908 1 | NS 304 01 | 02191908 1B | NS 3 04 01 | 31191908 1A | NS 3 04 00 | 05691908 1C |
| NS 3 04 01 | 11191908 1 | NS 304 02 | 02191908 1C | NS 4 19 01 | KDWHC09644 | NS 3 04 02 | 05691908 1C |
| NS 3 04 01 | 11391908 1 | NS 304 02 | 05691908 1C | NS 3 04 00 | 02191908 1C | | |

BAŞAK TRAKTÖR

| | | | | | | | |
|------------|------------------|-----------|------------------|------------|------------------|------------|------------------|
| NS 1 01 12 | 5320520058001300 | NS 124 02 | 9200580012 | NS 8 03 01 | 050.55.10 | NS 1 05 11 | 52.58.39 |
| NS 1 91 00 | 1925839 | NS 304 01 | 6100009 0003 | NS 8 03 02 | 050.55.10 | NS 4 16 01 | 52.71.01 |
| NS 1 34 01 | 1925800 39 | NS 406 01 | 5320600077024200 | NS 8 03 03 | 050.55.10 | NS 6 50 05 | 536 0801 8000 0 |
| NS 1 34 02 | 1925800 39 | NS 191 00 | 5320520058000300 | NS 1 91 00 | 052.58.03 | NS 6 50 06 | 536 0801 8000 0 |
| NS 1 34 01 | 3975800 03 | NS 803 02 | 5320520055000800 | NS 1 03 31 | 05200580004 | NS 3 04 01 | 609F070133 |
| NS 1 34 02 | 3975800 03 | NS 105 11 | 5320520058003900 | NS 1 34 00 | 192.58.39 | NS 3 04 02 | 609F070133 |
| NS 3 04 02 | 4070900 12 | NS 304 02 | 6100009 0003 | NS 1 24 00 | 27/950-110 | NS 2 04 00 | 612.09.0006 |
| NS 5 23 24 | 7803603 57 | NS 450 00 | 7023040 1200 | NS 4 16 01 | 53205271 0100 | NS 2 04 01 | 612.09.0006 |
| NS 5 23 24 | 3809360 155 | NS 523 24 | 7910071 0028 | NS 8 03 06 | 5320520055000800 | NS 6 50 05 | 680 58 00 89 |
| NS 8 03 02 | 5200550 008 | NS 449 00 | 7910071 0068 | NS 1 11 04 | 5340520058001400 | NS 6 50 06 | 680 58 00 89 |
| NS 8 03 03 | 5200550 010 | NS 523 02 | 9911471 0001 | NS 1 24 02 | 27/950-110 | NS 2 04 01 | X830030053000 |
| NS 4 06 01 | 6000770 242 | NS 401 00 | 1337007 10023 | NS 6 03 03 | 52.35.21 | NS 6 03 03 | 5340520035002100 |
| NS 1 24 00 | 9200580 012 | NS 191 00 | 5,931E+12 | NS 1 01 12 | 52.58.13 | NS 8 03 00 | 5320520055000800 |

BMC

| | | | | | | | |
|---------------|--------------|-----------|--------------|---------------|-------------|------------|--------------|
| NE 5002 | 51RS803284 | NS 908 01 | 58RS502908 | NS 4 45 00 | 9P908487 | NS 7 20 01 | 52RS008457 |
| NS 1 01 00 | 3R99 088 | NS 909 00 | 58RS100790 | NS 4 45 01 | 9P902652 | NS 7 21 00 | 9P910507 |
| NS 1 02 00 | 3M51624 | NS 909 01 | 58RS100789 | NS 4 47 00 | 9P900832 A | NS 7 22 00 | 53RS301033 |
| NS 1 02 00/1 | ADU15 73 | NS 912 00 | 58RS503022 | NS 4 50 00 | 9P900601 | NS 7 22 00 | 7C461 1450BA |
| NS 1 05 00 | 3K20473 6 | NS 912 01 | 58RS503021 | NS 4 60 00 | 9P924528 | NS 7 22 00 | 97CT1145 0BA |
| NS 1 05 00 | 58RS101509 | NS 913 00 | 58RS113028 | NS 4 61 00 | 9P909410 | NS 7 30 00 | 2PF001637-00 |
| NS 1 05 28 | 58RS600599 | NS 913 01 | 58RS113029 | NS 5 23 00 | KOC 8099 | NS 7 30 00 | 51RS980718 |
| NS 1 11 04 | 5200580 014 | NS 920 01 | 8B71 440 | NS 5 23 01 | 3K57942 | NS 7 30 00 | 54RS350009 |
| NS 1 11 04 | 52RS007114 | NS 920 02 | 9P91080 7 | NS 5 23 02 | 54RS510479 | NS 7 31 03 | 52RS019605 |
| NS 1 14 00 | 3M54488 | NS 922 02 | 58RS504435 | NS 5 23 09 | 53RS300846 | NS 8 04 00 | 2K63922 |
| NS 1 14 00/2 | 3M54488/2 | NS 930 00 | 8K56721 | NS 5 23 24 | 2501286 | NS 8 04 01 | 2K10450 |
| NS 1 15 00 | 3M65804 | NS 931 00 | 8K56813 | NS 5 24 00 | 52RS010525 | NS 8 20 00 | M4C7058 |
| NS 1 15 00/2 | 3M65804/2 | NS 931 00 | 8K56813-2 | NS 5 24 00 | KOC 8047 | NS 8 21 00 | K5C71 21 |
| NS 1 16 00 | 3M67262 | NS 934 00 | 58RS503730 | NS 9 51 00 08 | 58RS103569 | NS 8 21 01 | 51RS200483 |
| NS 1 16 00/1 | 3M67262/1 | NS 950 00 | 8K20474 8 | NS 9 51 00/B | 58 RS103400 | NS 8 22 01 | 52RS002531 |
| NS 1 17 00 | 3K63923 | NS 950 00 | 8R55 867 | NS 9 51 01 | 58RS103401 | NS 8 24 01 | M4C7058-1 |
| NS 1 17 00/2 | 3K63923/2 | NS 951 00 | 58RS103400 | NS 9 51 01 | 8K231989 | NS 8 29 00 | 58RS503260 |
| NS 1 30 00 | 51RS980719 | NS 951 00 | 8K23198 8 | NS 9 51 01/B | 58 RS103401 | NS 8 37 55 | 52RS031909 |
| NS 1 30 00 | 54RS350745 | NS 960 03 | 58RS103548 | NS 9 51 02 | 58RS103400 | NS 8 39 05 | 52RS020233 |
| NS 1 40 00 | 3M92304 | NS 252 00 | 3M13506 | NS 9 51 02 | 8K231988 | NS 8 39 05 | 55RS251812 |
| NS 1 40 00 | 58RS502904 | NS 301 00 | 13H6462YR | NS 9 51 03 | 58RS103401 | NS 8 44 01 | 52RS026751 |
| NS 1 40 00/1 | 58RS502904/1 | NS 301 00 | 2M201008 | NS 9 51 03 | 8K231989 | NS 8 44 04 | 52RS026751 |
| NS 1 41 00 | 58RS502922 | NS 302 00 | 6131124 3414 | NS 9 52 00 | 8K230118 | NS 8 44 18 | 55RS252349 |
| NS 1 41 00 | 8K23037 2 | NS 302 00 | 6131135 4272 | NS 9 52 01 | 8K230119 | NS 8 44 22 | 52RS026751 |
| NS 1 41 00/1 | 58RS502922/1 | NS 302 00 | 6131135 4273 | NS 9 54 00 | EMB K5B2129 | NS 8 45 00 | 51RS200483 |
| NS 1 41 00/1 | 8K23037 2-1 | NS 302 00 | 6131135 4274 | NS 9 57 00 | 8M201381 | NS 8 45 00 | 51RS802233 |
| NS 1 41 05 | 53RS300907 | NS 302 01 | 6131135 4272 | NS 9 58 00 | 8K 201369 | NS 8 56 00 | 52RS026751 |
| NS 1 41 07 | 53RS301409 | NS 302 01 | 6131135 4273 | NS 9 58 00 | 8K201369 | NS 8 58 00 | 52RS026751 |
| NS 1 41 12 | 53RS302250 | NS 302 01 | 6131135 4274 | NS 9 59 00 | 8M54578 | NS 8 65 00 | 53RS203169 |
| NS 1 47 00 02 | 53RS301750 | NS 304 01 | 6131135 1799 | NS 9 59 01 | 8M 54 577 | NS 9 02 00 | 58RS502905 |
| NS 1 48 00 | 53RS301902 | NS 304 01 | 6131135 4272 | NS 9 59 01 | 8M54577 | NS 9 02 00 | 8K230370 |

**BMC**

| | | | | | | | |
|------------|--------------|-----------|--------------|------------|------------|----------------|---------------|
| NS 14802 | 53RS302109 | NS 304 02 | 6131135 1799 | NS 96000 | 8M 63 235 | NS96007 | 58RS509909 |
| NS 16702 | 55RS351216 | NS 319 00 | 51RS200393 | NS 96000 | 8M63235 | NS 96100 | 8R204573 |
| NS 17000 | 55RS360119 | NS 319 00 | 51RS300771 | NS 96001 | 8M 63 236 | NS 97000 | 58RS112595 |
| NS 19400 | 2001859 6013 | NS 324 00 | 9P918232 | NS 96001 | 8M63236 | NS 97100 | 58RS112882 |
| NS 19400 | 3M90827 | NS 406 00 | 9P909593 | NS 96002 | 58RS103547 | NS 97200 | 58RS112597 |
| NS 19400 | 51RS301386 | NS 406 00 | ADU3354 | NS 96006 | 58RS509908 | NS 97600 | 38888275 0001 |
| NS 19401 | 51RS301384 | NS 406 01 | 51RS201450 | NS 5 24 01 | 52RS008938 | NS 97600 | 53RS801739 |
| NS 19404 | 202624 | NS 406 01 | 51RS300076 | NS 5 24 03 | 52RS010524 | NS 97600 | 58RS175387 |
| NS 19404 | 53RS301667 M | NS 408 06 | 55RS351242 | NS 5 24 04 | 54RS511422 | NS B 1 002 | 55RS251796 |
| NS 19405 | 53RS301903 | NS 413 00 | 3K11641 | NS 5 24 09 | 53RS300845 | NS B1 010 | 52RS024258 |
| NS 19500 | 3M90826 | NS 415 00 | 000A17030 | NS 5 24 14 | 52RS008938 | NS B 1012 00 | 57RS306711 |
| NS 19500 | 51RS301385 | NS 415 00 | 9P909767 | NS 5 24 17 | 54RS510450 | NSB 1 028 1 0 | 55RS360085 |
| NS 19800 | 52RS030304 | NS 415 00 | X11465 | NS 5 24 21 | 52RS028570 | NS B 1 063 0 0 | 53RS203172 |
| NS 19801 | 52RS030305 | NS 418 00 | 51RS300270 | NS 5 37 13 | 55RS351241 | NS B 2 010 | 58RS503259 |
| NS 20600 | K5E2017YR | NS 418 01 | 51RS300617 | NS 5 51 03 | S3000083A | NSB 2 056 | 51RS801887 |
| NS 20601 | 52RS010227 | NS 419 02 | 3K93122 | NS 6 50 05 | K8D4018 | NS B 2 074 | 52RS019737 |
| NS 20602 | K5E2017 | NS 419 05 | 51RS301557 | NS 6 50 06 | K8D4018 | NS B 2 075 | 52RS020193 |
| NS 2 1400 | 62110788115 | NS 432 00 | 51RS400578 | NS 6 51 00 | 51RS300429 | NS B 2 084 | 51 RS802243 |
| NS 90200/1 | 58RS113038 | NS 432 01 | 51RS400811 | NS 6 52 00 | 4192725 | NS B 2 086 | 53 RS807760 |
| NS 90201 | 58RS502906 | NS 441 00 | 4K97679 | NS 6 52 00 | 8354490 | NS B 2 096 | 58 RS508496 |
| NS 90201 | 8K23037 1 | NS 441 00 | 9P902065 | NS 6 52 00 | 8356483 | NS B 2 402 | 53 RS809147 |
| NS 90800 | 58RS102224 | NS 441 00 | 9P942792 | NS 6 55 03 | 53RS302128 | NSB 2 404 | 58RS600600 |
| NS 90800 | 58RS502907 | NS 442 00 | 4K97187 | NS 7 10 00 | 52RS002533 | NS B2 408 | 58RS510873 |
| NS 90801 | 58RS102225 | NS 442 00 | 9P900601 | NS 7 20 00 | 52RS008457 | NSB 2 409 | 55RS360086 |

BOSCH

| | | | | | | | |
|----------|------------|-----------|-------------|------------|-------------|------------|--------------|
| NS 13401 | 343008006 | NS 303 00 | 9863440 63 | NS 5 23 24 | 09863451 11 | NS5 51 01 | 09863451 10 |
| NS 13401 | 343008007 | NS 304 01 | 9863440 82 | NS 5 23 25 | 03440040 10 | NS5 51 01 | 09863451 18 |
| NS 13401 | 3430080099 | NS 304 01 | 9863440 85 | NS 5 34 01 | 02633006 30 | NS 6 50 05 | 0341 002 002 |
| NS 13402 | 343008006 | NS 304 02 | 9863440 58 | NS 5 51 00 | 09863451 12 | NS6 50 05 | 0341 002 003 |
| NS 13402 | 343008007 | NS 309 00 | 0986344 046 | NS 5 51 01 | 03440040 10 | NS 6 50 06 | 0341 002 002 |
| NS 13402 | 3430080099 | NS 523 02 | 0344400 008 | NS 5 51 01 | 03440040 18 | NS 6 50 06 | 0341 002 003 |
| NS 30100 | 9863440 74 | NS 523 02 | 0986345 408 | | | | |

CITROEN

| | | | | | | | |
|----------|------------|-----------|------------|------------|-------------|------------|------------|
| NS 22200 | 75.413.327 | NS 222 00 | 95.581.212 | NS 3 09 00 | 95.495.159 | NS 3 11 00 | 91.040.130 |
| NS 22200 | 95.494.830 | NS 309 00 | 75.413.615 | NS 3 09 00 | 95.562.366 | NS 3 11 00 | 91.521.113 |
| NS 22200 | 95.548.687 | NS 309 00 | 75.490.801 | NS 3 09 00 | 77006557 87 | NS 3 11 00 | 1131.14 |
| NS 22200 | 95.566.070 | NS 309 00 | 95.493.861 | NS 3 09 00 | 00038680 | | |

CLAAS

| | | | | | | | |
|----------|---------|-----------|----------|------------|-------------|------------|---------|
| NS 60301 | 1385700 | NS 652 00 | 3427270 | NS 8 14 01 | 177621.0 | NS 8 44 22 | 5812790 |
| NS 65005 | 5709840 | NS 652 00 | 3499920 | NS 8 37 12 | 77000553 71 | NS 8 56 00 | 5812790 |
| NS 65006 | 5709840 | NS 811 00 | 177621.0 | NS 8 44 01 | 5812790 | NS 8 58 00 | 5812790 |
| NS 65200 | 1385750 | NS 814 00 | 177621.0 | NS 8 44 04 | 5812790 | | |

CNH / TURK TRAKTOR

| | | | | | | | |
|----------|-------------|-----------|--------------|------------|---------------|------------------|----------------------|
| NS 10300 | 3107556 R92 | NS 124 03 | 3057508 R94 | NS 3 03 00 | 85950128 | NS4 2901 | 84219064 |
| NS 10300 | 3119716 R91 | NS 124 03 | 3136852 R1 | NS 3 04 01 | 13200001 0731 | NS 4 29 01 | YP84219064 |
| NS 10300 | 3127632 R91 | NS 124 04 | 1317005 8002 | NS 3 18 00 | 82847703 | NS 429 01 | YP842 19064-X |
| NS 10304 | 529800R91 | NS 124 04 | 3057508 R94 | NS 3 25 00 | 81711892 | NS 523 11 | YP5097694 |
| NS 10305 | 3107556 R92 | NS 124 04 | 3136852 R1 | NS 3 25 00 | 3055238R92 | NS 5 23 13 | 47579701 |
| NS 10305 | 3119716 R91 | NS 134 00 | 3057998 R91 | NS 3 25 00 | 3129031R91 | NS 5 23 13 | 87584696 |
| NS 10305 | 3127632 R91 | NS 837 12 | 226384A1 | NS 3 25 00 | 3132673R2 | NS 523 13 | YP87584696 |
| NS 10308 | 3048227 R92 | NS 837 12 | 277106A1 | NS 3 25 00 | 91450C1 | NS 523 13 | YP875 84696-X |
| NS 10308 | 3119716 R91 | NS 837 48 | 47363129 | NS 3 25 00 | 376855R92 | NS 523 18 | 3146055R1 |
| NS 10317 | 107556R92 | NS 837 48 | YP47363129 | NS 3 30 00 | 81711892 | NS 523 37 | 84577118 |
| NS 10317 | 3107556 R92 | NS 837 63 | 4735756 8 | NS 3 30 00 | 3055238R92 | NS5 24 04 | 5099414 |
| NS 10317 | 3119716 R91 | NS 837 63 | YP47357568 | NS 3 30 00 | 3129031R91 | NS 5 24 04 | YP5099414 |
| NS 10317 | 3127632 R91 | NS 843 05 | 3221253 R1 | NS 3 30 00 | 3132673R2 | NS5 24 23 | 84370675 |
| NS 10325 | 107556R92 | NS 844 01 | 8765145 3 | NS 3 30 00 | 376855R92 | NS 5 24 23 | YP84370675 |
| NS 10325 | 3107556 R92 | NS 134 00 | 3057998 R92 | NS 3 30 00 | 392249R92 | NS 5 24 33 | 84557962 |
| NS 10325 | 3119716 R91 | NS 134 00 | 3057998 R93 | NS 3 30 00 | 91450C1 | NS 551 01 | 3141703R1 |
| NS 10325 | 3127632 R91 | NS 134 00 | 3147176 R1 | NS 3 34 00 | 14070900 12 | NS 803 01 | 3137474R2 |
| NS 10328 | 3107556 R92 | NS 134 01 | 3057998 R93 | NS 3 34 00 | 16100009 0003 | NS 803 01 | 3221253R1 |
| NS 10328 | 3119716 R91 | NS 134 01 | 3147176 R91 | NS 3 34 00 | 02191908 1A | NS 803 02 | 3137474R2 |
| NS 10328 | 3127632 R91 | NS 134 02 | 3057998 R93 | NS 3 34 00 | 02191908 1B | NS 803 02 | 3221253R1 |

| CNH / TURK TRAKTOR | | | | | | | |
|--------------------|---------------|-----------|-------------|----------|----------------|-------------|-----------------|
| NS 104706 | YP47357536 | NS 134 02 | 3147176 R91 | NS 84401 | 1.33.755.005 | NS 80303 | 3137474R2 |
| NS 10600 | 5129862 | NS 202 00 | 81784077 | NS 84404 | 87651453 | NS 80303 | 3221253R1 |
| NS 10600 | 5146155 | NS 212 01 | YP5086043 | NS 84404 | 1.33.755.005 | NS8 2200 | 3221253R1 |
| NS 10601 | 5146155 | NS 223 00 | 9H12098 1A | NS 84422 | 87651453 | NS 82201 | 3221253R1 |
| NS 10800 | 1502378 C1 | NS 223 00 | A187687 | NS 84422 | 1.33.755.005 | NS8 2400 | 588974 |
| NS 10800 | 1502378 C2 | NS 226 01 | 3073787 R1 | NS 84601 | 5083677 | NS 82400 | 5088783 |
| NS 10802 | 1502378 C1 | NS 226 01 | 3127956 R1 | NS 84601 | YP5083677 | NS 82400 | 5139618 |
| NS 10802 | 1502378 C2 | NS 301 00 | 1534526 C1 | NS 84900 | 84183928 | NS 82400 | 5139618V |
| NS 10804 | 1502378 C1 | NS 301 00 | 1534526 C2 | NS 33400 | 299975A1 | NS 82400 | 672633A |
| NS 10804 | 3121404 R1 | NS 301 00 | 3060472 R91 | NS 33400 | 299975A2 | NS 83500 | 87547768 |
| NS 10902 | 2.7409.500.0 | NS 301 00 | 3599307 R91 | NS 33400 | 717576R91 | NS 83500 | YP87547768 |
| NS 11101 | 1502379 C1 | NS 301 00 | 91952C3 | NS 40701 | 81817901 | NS 83600 | 44907408 |
| NS 11101 | 3107344 R91 | NS 302 01 | 4998770 | NS 40902 | 3146358R1 | NS 83600 | 87547770 |
| NS 11106 | 1502379 C1 | NS 302 01 | 4998770 | NS 40902 | 3147137R1 | NS 83600 | YP87547770 |
| NS 11106 | 3107344 R91 | NS 303 00 | 8187352 4 | NS 40902 | 3401400R1 | NS 84900 | YP84183928 |
| NS 12400 | 1317005 80002 | NS 303 00 | 82028130 | NS 41400 | 3072122R94 | NS 84901 | YP84477819 |
| NS 12400 | 3136852 R1 | NS 303 00 | 8391285 4 | NS 41400 | 3114409R92 | NS 85600 | 87651453 |
| NS 12402 | 1317005 80002 | NS 303 00 | 8395305 6 | NS 41600 | YP5109221 | NS 85600 | 1.33.755.005 |
| NS 12402 | 3136852 R1 | NS 303 00 | 8395305 7 | NS 42900 | 84219065 | NS 85800 | 87651453 |
| NS 12403 | 1317005 8002 | NS 303 00 | 8395309 6 | NS 42900 | YP84219065 | NS 85800 | 1.33.755.005 |
| COBO | | | | | | | |
| NS 65005 | 13.002.000 | NS 106 01 | 14.159.000 | NS 13000 | 3M424N4620 | NS 42100 | 17.170.000 |
| NS 65006 | 13.002.000 | NS 106 01 | 14.186.000 | NS 10902 | 23.108.000 | NS 65500 | 13.001.000 |
| NS 10600 | 14.159.000 | NS 106 00 | 14.186.000 | | | | |
| ÇUKUROVA MAKİNA | | | | | | | |
| NS 10601 | 14.159.000 | NS 421 00 | 17.170.000 | NS 65500 | 13.001.000 | NS 84309 | 000C19C34 |
| NS 10601 | 14.186.000 | NS 650 05 | 13.002.000 | NS 82200 | 000C19A54 | NS 84500 | 000C 237F81 |
| NS 10902 | 23.108.000 | NS 650 06 | 13.002.000 | NS 83715 | 000C20D26 | NS B 100001 | 000C20D25 |
| NS 13000 | 3M424N4620 | | | | | | |
| DACIA | | | | | | | |
| NS 30900 | 5633298 | NS 309 00 | 6000036 106 | | | | |
| DAF | | | | | | | |
| NS 13000 | 72255 | NS 814 03 | 1.305.197 | NS 52409 | 1517997 | NS 84401 | 1354098 |
| NS 19404 | 064 16275 | NS 822 00 | 1315785 | NS 52412 | 815867 | NS 84401 | 1687523 |
| NS 55101 | 170659 | NS 822 01 | 1315785 | NS 52413 | 578466 | NS 84404 | 1354098 |
| NS 65005 | 122443 | NS 843 05 | 1315785 | NS 52413 | 1504932 | NS 84404 | 1687523 |
| NS 65006 | 122443 | NS 866 01 | 1742568 | NS 52414 | 1505470 | NS 84422 | 1354098 |
| NS 65200 | 1279537 | NS 866 03 | 1742568 | NS 52415 | 371993 | NS 84422 | 1687523 |
| NS 65200 | 1359968 | NS 304 01 | 690314 | NS 81100 | 131585 | NS 85600 | 131585 |
| NS 80301 | 109996 | NS 304 01 | 833429 | NS 81100 | 1697734 | NS 85600 | 1354098 |
| NS 80301 | 288491 | NS 304 02 | 690314 | NS 81100 | 2534687 | NS 85600 | 1687523 |
| NS 80301 | 1315785 | NS 304 02 | 833429 | NS 81400 | 131585 | NS 85600 | 1697734 |
| NS 80302 | 109996 | NS 441 00 | 0287296 | NS 81400 | 288491 | NS 85600 | 2534687 |
| NS 80302 | 288491 | NS 523 00 | 1517996 | NS 81400 | 288639 | NS 85800 | 131585 |
| NS 80302 | 1315785 | NS 523 02 | 533633 | NS 81400 | 1697734 | NS 85800 | 1354098 |
| NS 80303 | 109996 | NS 523 03 | 150549 | NS 81401 | 131585 | NS 85800 | 1687523 |
| NS 80303 | 288491 | NS 523 03 | 1187449 | NS 81401 | 288491 | NS 85800 | 1697734 |
| NS 80303 | 1315785 | NS 523 24 | 208169 | NS 81401 | 288639 | NS 85800 | 2534687 |
| NS 81102 | 1.305.197 | NS 524 00 | 1505051 | NS 81401 | 1697734 | NS 86602 | 1742568 |
| NS 81402 | 1.305.197 | | | | | | |
| ERKUNT TRAKTÖR | | | | | | | |
| NS 10600 | 101367 | NS 107 08 | 103394 | NS 65500 | E060017744991 | NS 83716 | E0600155433 21. |
| NS 10601 | 101367 | NS 304 04 | 104715 | NS 83704 | E0600155433 21 | NS 84600 | 101354 |
| NS 10703 | 6001773 9911 | NS 419 01 | 100252 | NS 83712 | 15543321 | NS B 1215 | E060017746121 |
| EVOBUS | | | | | | | |
| NS 52303 | 7314041 000 | NS 524 01 | 7314016 000 | NS 52408 | 70314035 000 | NS 65200 | 5454908 |
| FAE | | | | | | | |
| NS 53700 | 18101 | NS 302 00 | 11200 | NS 33000 | 12040 | NS 44501 | 40690 |
| NS 53707 | 18105 | NS 302 01 | 11200 | NS 33700 | 11610 | NS 44600 | 25100 |
| NS 55103 | 21060 | NS 303 00 | 11320 | NS 40602 | 40960 | NS 44800 | 41200 |



| FAE | | | | | | | |
|----------|-------|-----------|-------|-----------|-------|-----------|-------|
| NS 20100 | 31270 | NS 311 00 | 11270 | NS 415 01 | 40120 | NS 448 01 | 40410 |
| NS 20200 | 31270 | NS 319 00 | 11610 | NS 435 00 | 25060 | NS 449 00 | 40450 |
| NS 30100 | 11420 | NS 319 00 | 11730 | NS 435 00 | 25080 | NS 450 00 | 40440 |
| NS 30100 | 13280 | NS 324 00 | 11280 | NS 437 00 | 24010 | NS 460 00 | 41301 |
| NS 30100 | 13335 | NS 325 00 | 12040 | NS 441 00 | 41120 | NS 462 00 | 41300 |
| NS 30101 | 1348 | NS 330 00 | 11420 | NS 442 00 | 40420 | | |

| FARGO | | | | | | | |
|----------|-----------|-----------|------------|-----------|-----------|-----------|---------|
| NS 15000 | 000A28322 | NS 420 00 | 000A34599T | NS 4 1901 | 31737 | NS 4 1901 | PRC8548 |
| NS 15002 | 000A28322 | NS 524 07 | 000A39539T | NS 4 1901 | 000A31737 | NS 4 2000 | 20933T |
| NS 41500 | 17030 | | | | | | |

| FENDT | | | | | | | |
|----------|---------------|-----------|---------------|-----------|---------------|-----------|---------------|
| NS 80301 | G524200061020 | NS 811 00 | G178200060010 | NS 134 01 | F228900020071 | NS 304 01 | 20200110011 |
| NS 80302 | G524200061020 | NS 814 00 | G178200060010 | NS 134 02 | F228900020071 | NS 304 01 | F020200110011 |
| NS 80303 | G524200061020 | NS 814 01 | G178200060010 | NS 204 00 | X830030053000 | NS 309 00 | 4988617 |

| FIAT / NEW HOLLAND / FORD TRAKTÖR / TÜRK TRAKTÖR | | | | | | | |
|--|--------------|-----------|-------------------|----------|---------------|------------------|---------------------|
| NS 10101 | 83932440 | NS 111 07 | C7NN11654B | NS 30200 | 5165458 | NS 42901 | 84212064 |
| NS 10101 | 87524407 | NS 111 07 | C7NN11654C | NS 30200 | 12326780 | NS 42901 | 84219064 |
| NS 10102 | 81876627 | NS 111 07 | D10026500 | NS 30200 | 79058146 | NS 42901 | 87660978 |
| NS 10102 | E8NN11N572AB | NS 111 07 | D5NN11654B | NS 30200 | 82036587 | NS 42901 | YP84219064 |
| NS 10303 | 83932446 | NS 111 07 | E7NN11654AA | NS 30200 | 87548759 | NS 429 01 | YP84219064-X |
| NS 10303 | D5NN11N501A | NS 113 00 | 4159884 | NS 30200 | 97201368 | NS 43000 | 4998897 |
| NS 10303 | E7NN11N501AB | NS 113 00 | 4180375 | NS 30201 | 4835 | NS 43000 | 5101414 |
| NS 10303 | E7NN11N572AA | NS 113 00 | 4184377 | NS 30201 | 5635 | NS 43000 | 31-2904521 |
| NS 10303 | E8NN11N572AA | NS 113 00 | 5086005 | NS 30201 | 6635 | NS 43000 | 31-2905837 |
| NS 10303 | E8NN11N572AB | NS 127 03 | 83932446 | NS 30201 | 7635 | NS 43000 | 62R413 |
| NS 10306 | C5NN11N572A | NS 127 03 | C5NN11N501A | NS 30201 | 415164 | NS43700 | 3900908 |
| NS 10306 | D5NN11N501A | NS 127 03 | C5NN11N572A/34228 | NS 30201 | 4151243 | NS 43700 | 3904637 |
| NS 10308 | 20A1745 | NS 127 03 | D4NN11N056A | NS 30201 | 4152127 | NS 43700 | 3917315 |
| NS 10310 | 50717016 | NS 127 03 | D5NN11N501A | NS 30201 | 4304418 | NS 43700 | 3921883 |
| NS 10310 | 81838692 | NS 127 03 | E2NN11N056AA | NS 30201 | 4305685 | NS 43700 | 4035221 |
| NS 10310 | 81871583 | NS 127 03 | E7NN11N501AB | NS 30201 | 4411183 | NS 43700 | 4067916 |
| NS 10310 | 82849085 | NS 127 03 | E7NN11N572AA | NS 30201 | 4431182 | NS 43700 | 4124209 |
| NS 10310 | 83902803 | NS 127 03 | E8NN11N572AA | NS 30201 | 4459908 | NS 43700 | 4177122 |
| NS 10310 | 83959710 | NS 127 03 | E8NN11N572AB | NS 30201 | 4473333 | NS 43700 | 4177124 |
| NS 10310 | 83976890 | NS 127 06 | C5NN11N572A | NS 30201 | 4998770 | NS 43700 | 4177172 |
| NS 10310 | 83999543 | NS 127 06 | D5NN11N501A | NS 30201 | 4998771 | NS 43700 | 4220470 |
| NS 10310 | 87554837 | NS 127 10 | 50717016 | NS 30201 | 5107603 | NS 43700 | 4220471 |
| NS 10310 | C5NN11N501A | NS 127 10 | 81838692 | NS 30201 | 5160694 | NS 43700 | 4331975 |
| NS 10310 | C5NN11N572A | NS 127 10 | 81871583 | NS 30201 | 5165458 | NS 43700 | 4345645 |
| NS 10310 | D1NN11603B | NS 127 10 | 82849085 | NS 30201 | 12326780 | NS 43700 | 4356090 |
| NS 10310 | D3NN11N501A | NS 127 10 | 83902803 | NS 30201 | 79058146 | NS 43700 | 4381973 |
| NS 10310 | D5NN11A578A | NS 127 10 | 83959710 | NS 30201 | 82036587 | NS 43700 | 82304822 |
| NS 10310 | D5NN11N501A | NS 127 10 | 83976890 | NS 30201 | 97201368 | NS 43700 | 82416969 |
| NS 10310 | D5NN11N572A | NS 127 10 | 83999543 | NS 30201 | 1131.44 | NS 44900 | 88DB15520AA |
| NS 10310 | E7NN11N501A | NS 127 10 | 87554837 | NS 30201 | 4151246 | NS 52302 | 3416590 |
| NS 10310 | E7NN11N501AA | NS 127 10 | C5NN11N501A | NS 30201 | 4151564 | NS 52311 | YP5097694 |
| NS 10310 | E7NN11N501AB | NS 127 10 | C5NN11N572A | NS 30201 | 4431183 | NS 52313 | 47579701 |
| NS 10310 | E7NN11N501AC | NS 127 10 | D1NN11603B | NS 30201 | 87694746 | NS 52313 | 87584696 |
| NS 10310 | E8NN11N501AA | NS 127 10 | D3NN11N501A | NS 30201 | 92701368 | NS 52313 | 87584696 - Eski Kod |
| NS B 104706 | YP47357536 | NS 127 10 | D5NN11A578A | NS 30300 | D8NN9278AA | NS 52313 | YP87584696 |
| NS 10600 | 5107623 | NS 127 10 | D5NN11N501A | NS 12710 | E7NN11N501AB | NS 523 13 | YP87584696-X |
| NS 10600 | 5129862 | NS 127 10 | D5NN11N572A | NS 30300 | D8NN9278BD | NS 52324 | V78RB7E440AA |
| NS 10600 | 4998108 | NS 127 10 | E7NN11N501A | NS 30300 | F1NN9278AA | NS52337 | 84577118 |
| NS 10601 | 4998108 | NS 127 10 | E7NN11N501AA | NS 30304 | 84053656 | NS 52404 | 5097529 |
| NS 10601 | 5107623 | NS 127 10 | E7NN11N501AC | NS 30402 | 60506902 | NS 52404 | 5097832 |
| NS 10601 | 5112124 | NS 127 10 | E8NN11N501AA | NS 30402 | 60593846 | NS 52404 | 5099414 |
| NS 10601 | 5123727 | NS 127 12 | 81806736 | NS 30402 | 60594694 | NS 52404 | 47134924 |
| NS 10601 | 5129862 | NS 127 12 | 81836693 | NS 30402 | 1,05481E+11 | NS 52404 | YP5099414 |
| NS 10601 | 5146155 | NS 127 12 | 81838693 | NS 30500 | 7072644 | NS 52412 | 3C4613480DA |
| NS 10700 | 4998108 | NS 127 12 | 82849165 | NS 30500 | V94DD-9278-AA | NS52423 | 84370675 |
| NS 10700 | 5086005 | NS 127 12 | 89843617 | NS 30900 | 3240239 | NS 52423 | YP84370675 |
| NS 10700 | 5107623 | NS 127 12 | C5NN11N572A | NS 30900 | 3248349 | NS 52433 | 84557962 |
| NS 10700 | 5112124 | NS 127 12 | C5NN11N572A | NS 30900 | 3896007 | NS 55100 | 73127291 |
| NS 10700 | 5123727 | NS 127 12 | C5NN11N572A | NS 30900 | 3901430 | NS 55100 | 76008494 |

ÇAPRAZ REFERANSLAR

CROSS REFERENCES

QUEVERNEISE



FIAT / NEW HOLLAND / FORD TRAKTÖR / TÜRK TRAKTÖR

| | | | | | | | |
|----------|-------------|-----------|-------------|-----------|--------------|-----------|--------------|
| NS 10700 | 5129862 | NS 127 12 | D3NN11N572A | NS 3 0900 | 3911925 | NS 5 5104 | 80354372 |
| NS 10700 | 5146155 | NS 127 12 | D3NN11N572A | NS 3 0900 | 3928822 | NS 6 0300 | 4954118 |
| NS 10700 | 31-2904520 | NS 201 00 | 173321 | NS 3 0900 | 4133922 | NS 6 0300 | 5085964 |
| NS 10700 | 31-2906469 | NS 201 00 | 1784077 | NS 3 0900 | 4220161 | NS 6 0300 | 5086011 |
| NS 10700 | 31V2906469 | NS 201 00 | 6076967 | NS 3 0900 | 4298311 | NS 6 0300 | 87569365 |
| NS 10701 | 4998108 | NS 201 00 | 81784077 | NS 3 0900 | 4414583 | NS 6 0301 | 5121786 |
| NS 10701 | 5086005 | NS 201 00 | 3840322 49 | NS 3 0900 | 4414599 | NS 6 0301 | 5152966 |
| NS 10701 | 5107623 | NS 201 00 | C4AH10884AA | NS 3 0900 | 4422049 | NS 6 0305 | 80470041 |
| NS 10701 | 5112124 | NS 201 00 | C5NN1 0884A | NS 3 0900 | 4459907 | NS 6 0400 | 175035 |
| NS 10701 | 5123727 | NS 201 00 | D1NN10884A | NS 3 0900 | 4988617 | NS 6 0400 | 4954118 |
| NS 10701 | 5129862 | NS 201 00 | D8NN20994A | NS 3 0900 | 5428609 | NS 6 0400 | 5086011 |
| NS 10701 | 5146155 | NS 202 00 | 6108298 | NS 3 0900 | 5556502 | NS 6 0400 | 5121786 |
| NS 10701 | 31-2904520 | NS 202 00 | 6136366 | NS 3 0900 | 5556508 | NS 6 0400 | 87569365 |
| NS 10701 | 31-2906469 | NS 202 00 | 6146864 | NS 3 0900 | 5967744 | NS 6 5005 | 46975 |
| NS 10701 | 31V2906469 | NS 202 00 | 82GB10884BA | NS 3 0900 | 60504196 | NS 6 5005 | 3431319 |
| NS 10900 | 4998107 | NS 202 00 | 85FB10884AA | NS 3 1100 | 866B9 278AB | NS6 5005 | 4822229 |
| NS 10900 | 5086829 | NS 202 00 | 86AB10884AA | NS 3 1900 | 3024539 | NS 6 5006 | 3431319 |
| NS 10900 | 5118433 | NS 202 00 | C4AH10884AA | NS 3 1900 | 3600688 | NS 6 5006 | 4822229 |
| NS 10900 | 5125958 | NS 202 00 | C5NN1 0884A | NS 3 1900 | 71742590 | NS 7 2100 | 81712505 |
| NS 10900 | 5132021 | NS 202 00 | D8NN20994A | NS 3 1900 | E9BZ-9278-A | NS7 2100 | E1ADDN11450C |
| NS 10900 | 9998786 | NS 205 00 | 4178363 | NS 3 1900 | F0BZ-9278-A | NS 8 0301 | 77DB9A107AB |
| NS 10900 | 79057306 | NS 205 00 | 5108205 | NS 3 1900 | F1CZ-9278-A | NS 8 0301 | 97CT9A107BA |
| NS 10900 | 82984103 | NS 205 00 | 72090718 | NS 3 1900 | F4BZ-9278-A | NS 8 0302 | 77DB9A107AB |
| NS 10902 | 4998107 | NS 205 00 | 72091945 | NS 3 1900 | F5Z2-9278-AA | NS 8 0303 | 77DB9A107AB |
| NS 10902 | 5086008 | NS 205 00 | 87569357 | NS 3 2500 | 100E9278 | NS 8 1100 | 1369849 |
| NS 10902 | 5132021 | NS 205 00 | 87694765 | NS 3 2500 | 6090246 | NS 8 1400 | 1369849 |
| NS 10902 | 72093881 | NS 208 00 | 83903061 | NS 3 2500 | 6163243 | NS 8 1401 | 1369849 |
| NS 10902 | 79057306 | NS 208 00 | D5NN10884A | NS 3 2500 | 6703036 | NS 8 2300 | 4011011 |
| NS 10902 | 82984103 | NS 208 00 | D8NN10884A | NS 3 2500 | 92VB9278AA | NS8 2300 | 4117122 |
| NS 11000 | 4158641 | NS 208 01 | 9712608 | NS 3 2500 | DORY-9278-A | NS 8 2300 | 4988782 |
| NS 11000 | 5086938 | NS 208 01 | 82028131 | NS 3 3000 | 6703036 | NS 8 2300 | 5118532 |
| NS 11000 | 5097530 | NS 208 01 | 82034415 | NS 3 3000 | 100E9278 | NS 8 2300 | 44901657 |
| NS 11000 | 5118433 | NS 208 01 | 83911735 | NS 3 3000 | 100E9278 | NS 8 2300 | 153624488 |
| NS 11000 | 7209381 | NS 208 01 | 83917490 | NS 3 3000 | 100E9278 | NS 8 2300 | 301506152 |
| NS 11000 | 9918786 | NS 208 01 | 83926265 | NS 3 3000 | 92VB9278AA | NS 8 3400 | 81711548 |
| NS 11000 | 72093881 | NS 208 01 | 83948391 | NS 3 3700 | 3024539 | NS 8 3400 | 528E8100A |
| NS 11000 | 62R2 79 | NS 208 01 | 87307746 | NS 3 3700 | 3600688 | NS 8 3500 | 82000289 |
| NS 11000 | 677503AS | NS 208 01 | 87307746 | NS 3 3700 | E9BZ-9278-A | NS 8 3500 | 82009352 |
| NS 11000 | 7209388 1V | NS 208 01 | 87307746 | NS 3 3700 | F0BZ-9278-A | NS8 3500 | 82012210 |
| NS 11100 | 81818408 | NS 208 01 | 89712608 | NS 3 3700 | F1CZ-9278-A | NS 8 3500 | 87547528 |
| NS 11100 | 81818781 | NS 208 01 | D8NN10884A | NS 3 3700 | F4BZ-9278-A | NS 8 3500 | 87547768 |
| NS 11100 | 83905862 | NS 212 00 | 4178363 | NS 3 3700 | F5Z2-9278-AA | NS 8 3500 | YP87547768 |
| NS 11100 | 83959708 | NS 212 00 | 5108205 | NS 4 0100 | 81834441 | NS 8 3600 | 12339143 |
| NS 11100 | C5NN1 1654A | NS 212 00 | 72090718 | NS 4 0100 | 83952126 | NS 8 3600 | 44907408 |
| NS 11100 | C7NN1 1654B | NS 212 00 | 72091945 | NS 4 0100 | 84349105 | NS 8 3600 | 87547760 |
| NS 11100 | C7NN1 1654C | NS 212 00 | 87569357 | NS 4 0100 | D3NN13480A | NS8 3600 | 87547770 |
| NS 11100 | D10026500 | NS 212 00 | 87694765 | NS 4 0100 | E4NN13480AA | NS 8 3600 | YP87547770 |
| NS 11100 | D5NN11654B | NS 212 01 | 5086043 | NS 4 0700 | 81806706 | NS 8 3602 | 4181662 |
| NS 11100 | D7NN11654AA | NS 212 01 | YP5086043 | NS 4 0700 | C5NN11 N500A | NS 8 3602 | 5105346 |
| NS 11100 | D8NN11654AA | NS 222 00 | 5494830 | NS 4 0701 | C7NN7A247A | NS8 3602 | 9960827 |
| NS 11100 | E7NN11654AA | NS 224 00 | 81784007 | NS 4 1400 | 81712538 | NS 8 3602 | 154213036 |
| NS 11101 | 82848510 | NS 224 00 | 87554838 | NS 4 1400 | E1ADDN11500 | NS 8 3602 | 700706814 |
| NS 11101 | 83905862 | NS 224 00 | 817840077 | NS 4 1600 | 4073976 | NS 8 3602 | 50228120 400 |
| NS 11101 | 83959708 | NS 224 00 | C4AH10884A | NS 4 1600 | 5086135 | NS 8 3712 | 82011472 |
| NS 11101 | 83976890 | NS 301 00 | D8NN9278AA | NS 4 1600 | 5109221 | NS 8 3748 | 47363129 |
| NS 11101 | C5NN1 1654A | NS 302 00 | 4151243 | NS 4 1600 | 72091942 | NS 8 3748 | YP47363129 |
| NS 11101 | C5NN1 1654D | NS 302 00 | 4151546 | NS 4 1600 | 677478AS | NS 8 3763 | 47357568 |
| NS 11101 | C7NN1 1654B | NS 302 00 | 4152127 | NS 4 1600 | 72091942 V | NS 8 3763 | YP47357568 |
| NS 11101 | C7NN1 1654C | NS 302 00 | 4304418 | NS 4 1600 | YP5109221 | NS 8 3804 | 87610994 |
| NS 11101 | D5NN11654B | NS 302 00 | 4305685 | NS 4 2900 | 4998897 | NS 8 3804 | 87679919 |
| NS 11101 | E0NN585BA | NS 302 00 | 4411183 | NS 4 2900 | 5097530 | NS 8 4600 | 5083677 |
| NS 11101 | E7NN11654AA | NS 302 00 | 4431182 | NS 4 2900 | 5101414 | NS 8 4600 | 5094421 |
| NS 11102 | 82848509 | NS 302 00 | 4459908 | NS 4 2900 | 5140584 | NS 8 4601 | YP5083677 |
| NS 11102 | 83913707 | NS 302 00 | 4473333 | NS 4 2900 | 9958317 | NS 8 4900 | 84183928 |
| NS 11106 | E0NN585BA | NS 302 00 | 4998770 | NS 4 2900 | 44902423 | NS 8 4900 | YP84183928 |
| NS 11107 | 82848510 | NS 302 00 | 4998771 | NS 4 2900 | 84219065 | NS 8 4901 | YP84477819 |
| NS 11107 | 83905862 | NS 302 00 | 4999853 | NS 4 2900 | YP84219065 | NS 8 5103 | 51735617 |

**FIAT / NEW HOLLAND / FORD TRAKTÖR / TÜRK TRAKTÖR**

| | | | | | | | |
|----------|------------|-----------|---------|-----------|----------|-----------|----------|
| NS 11107 | 83959708 | NS 302 00 | 5107603 | NS 4 2901 | 10120428 | NS 851 05 | 51735617 |
| NS 11107 | C5NN11654A | NS 302 00 | 5160694 | NS 4 2901 | 31355810 | NS 94600 | 8001150 |
| NS 11107 | C5NN11654D | | | | | | |

FORD T.I.R.

| | | | | | | | |
|------------|--------------------|-------------------|---------------|------------|----------------|--------------|----------------|
| NE 4004 00 | DC46 9275 GA | NS 460 00 | 7C467L074CA | NS 7 07 00 | CC 46 9A089 AA | NS 8 45 03 | 9C46 9A107 BA |
| NE 4004 01 | DC46 9275 FA | NS 460 03 | DC46 13480 GA | NS 7 22 00 | 7C46 11450 BA | NS 8 50 05 | CC 46 90 30 BB |
| NE 4004 02 | DC46 9275 EA | NS 461 00 | 7C467L074AA | NS 7 22 00 | 97CT11450B | NS 8 50 06 | CC 46 90 30 AB |
| NE 4004 03 | DC46 9275 HA | NS 524 08 | 1C44 2937AA | NS 7 22 01 | 7C46 11450AA | NS 8 56 00 | 9C469A107AA |
| NE 4004 04 | DC46 9275 JA | NS 524 08 | 8C46 2937 AA | NS 7 22 01 | 7C4611450AA | NS 8 58 00 | 9C469A107AA |
| NE 4004 05 | DC46 9275 KA | NS 524 08 | 8C46 2937AA | NS 8 03 02 | 40291 | NS 9 15 00 | C0594 |
| NE 4004 07 | DC46 9275 LA | NS 524 27 | DC46 13480 BA | NS 8 03 02 | 2993920 | NS 9 15 01 | C0595 |
| NE 4501 00 | DC46 13480 EA | NS 535 00 | 3C46 2937CA | NS 8 03 02 | 97CT9A107BA | NS 9 15 02 | 6C46 E22050 AA |
| NS 142 00 | 6C46 3675 AA | NS 535 00 | 7C46 2937 AA | NS 8 03 03 | 40291 | NS B 1 01001 | 9C46 18D684 AA |
| NS 142 01 | 6C46 3675AA | NS 535 00 | 7C46 2937 AB | NS 8 03 03 | 2993920 | NS B1 01002 | AC 46 9K299 AA |
| NS 142 01 | 81DB-3675AL | NS 535 00 | 7C46 2937AB | NS 8 03 03 | 97CT9A107BA | NS B 1 01600 | 9C46 13R363 AA |
| NS 142 02 | 7C46 3675 AA | NS 537 00 | 3C46 13480BA | NS 8 37 10 | 7C46 5J239AC | NS B 2 122 | 6C46 3688 AB |
| NS 142 03 | FC46 3F880 AA | NS 537 00 | 8C46 13480 AA | NS 8 37 11 | 7C46-5J239-AD | NS B 2 136 | 6C46 3688 BA |
| NS 165 00 | 4C46 11654AA | NS 537 00 | 8C46 13480AA | NS 8 37 11 | 7C46-5J239-AD | NS B 2 157 | VAC46 3688 AB |
| NS 19405 | 9C46 11K661AA | NS 537 00-C | 8C46 13480 AC | NS 8 37 18 | 7C46-5J239-AD | NS B 2 158 | AC 46 3688 AB |
| NS 19801 | 9C46 2D25 5AA | NS 537 01 | 3C46 13480CA | NS 8 37 18 | 7C46-5J239-AD | NS B 2 159 | AC 46 3688 CB |
| NS 202 00 | EM /YM 25.24-32.30 | NS 537 01 | 8C46 13480 BC | NS 8 43 04 | 6C46 9A107 AB | NS B 2 160 | AC 46 3688 BC |
| NS 2 121 | 6C46-E22050AA | NS 537 01 | 8C46 13480BA | NS 8 43 04 | 6C46 9A107 AC | NS B 2 161 | AC 46 3688 AC |
| NS 2 123 | 6C46 3688 BB | NS 537 01-B | 8C46 13480 BB | NS 8 43 04 | 6C46 9A107 AD | NS B 2 163 | 8C46 3688 AB |
| NS 2 124 | 7C46 3688 AA | NS 537 06 | DC46 13480 DA | NS 8 43 05 | 6C46-9A107-AA | NS B 2 170 | DC46 3688 AD |
| NS 2 124 | 7C46 3688 AB | NS 537 09 | 8C46 13480 BC | NS 8 43 15 | 6C46 9A107 AE | NS B 2 171 | DC46 3688 CB |
| NS 2 132 | 8C46 3688 AA | NS 537 16 | DC46 13480 FA | NS 8 44 01 | 9C469A107AA | NS B 2 173 | VCC46 3688 AC |
| NS 2 136 | 8C46 3688 BA | NS 537 17 | GC46 13480 CA | NS 8 44 04 | 9C469A107AA | NS B 2 179 | DC46 3688 CE |
| NS 2 2400 | 91CT10884AA | NS 655 00 | 8C46-14526-AA | NS 8 44 09 | 9C46 9A107 AA | NS B 2 198 | DC46 3688 CE |
| NS 254 00 | EM/YM 25.24-32.30 | NS 655 02 | 8C46 14526 AA | NS 8 44 14 | 9C46 9A107 AB | | |
| NS 421 00 | 50467C534AA | NS 655 02 - FWALB | 8C46 14526 AA | NS 8 44 22 | 9C469A107AA | | |

HATTAT

| | | | | | | | |
|-----------|---------------|-----------|---------------|------------|-----------------|------------|-----------------|
| NS 101 14 | 325.53.200 | NS 191 00 | 001561-001 | NS 4 16 00 | 6440000 | NS 650 06 | 6EK 001 559 007 |
| NS 101 14 | 6VA1 5915 A1A | NS 191 00 | 1000295 T1 | NS 4 16 00 | 9.6440 | NS 650 06 | 6EK 001 559 011 |
| NS 101 14 | 6VA15915 A1A | NS 207 01 | 1877731 T92 M | NS 4 19 01 | 6ZP0053 88-001 | NS 650 06 | 6EK 001 559 031 |
| NS 101 53 | 1HT1 5800 A1A | NS 222 00 | 9.5521 | NS 4 19 05 | 6VA16017 A1A | NS 652 00 | 6EK00155900 1 |
| NS 101 53 | 1HT15800A1A | NS 223 00 | 9HH12009 B1A | NS 4 19 05 | 6VA16017A6A | NS 652 00 | 6EK00284300 1 |
| NS 103 00 | 8VA1 5840A1A | NS 301 00 | 1000355 K1 | NS 4 25 00 | 001.37.250 | NS 652 00 | 6EK00284300 2 |
| NS 103 15 | 002.37.310 | NS 302 00 | 6ZL0032591 21 | NS 4 30 08 | ACV02 20500 | NS 652 00 | 6EK00284300 3 |
| NS 103 15 | GUT15851A1A | NS 302 01 | 6ZL003259-121 | NS 5 24 23 | DV016011C | NS 652 00 | 6EK00284300 7 |
| NS 103 24 | 1874120 T93 M | NS 303 00 | 6ZL0032592 81 | NS 5 28 00 | 1693367M1M | NS 652 00 | 6EK00284308 7 |
| NS 103 25 | 1000299 K1 | NS 304 01 | 6ZL0032593 91 | NS 5 28 02 | 36755300 | NS 652 00 | 6EK00877601 1 |
| NS 103 50 | GUT1 5851 A1A | NS 309 00 | 9.5633 | NS 5 28 02 | 43000033 19 | NS 652 00 | 6EK00877602 1 |
| NS 108 02 | 1000292 T1 | NS 330 00 | 6ZL0032593 81 | NS 6 01 00 | 1000373T1 | NS 652 00 | 6EK00877603 1 |
| NS 109 00 | 002.37.320 | NS 408 01 | 1000369 K1 | NS 6 01 01 | 9.6419 | NS 652 00 | 6EK00877651 |
| NS 109 02 | 0013598 U91M | NS 408 01 | 3761983 M1 | NS 6 50 05 | 6EK 001 559 001 | NS 8 37 47 | 7VA1 5523 A1A |
| NS 112 00 | 1000290 T1 | NS 409 00 | 2HM1 5807 A1A | NS 6 50 05 | 6EK 001 559 007 | NS 8 37 79 | 3HT1 1904 A1A |
| NS 113 00 | 002.37.330 | NS 409 02 | 6VA1 5813 A1A | NS 6 50 05 | 6EK 001 559 011 | NS 8 52 02 | 1HM1 5024 A1A |
| NS 130 00 | 005389-00-AZ1 | NS 409 02 | 6VA15813 A1A | NS 6 50 05 | 6EK 001 559 031 | NS 9 45 00 | 9HT1 6104 A1A |
| NS 130 00 | 0C02 139000 | NS 410 00 | 0017143 U91M | NS 6 50 06 | 6EK 001 559 001 | NS 9 45 01 | 9HT1 6118 A1A |
| NS 130 00 | 0M06341000 | NS 183 00 | 1000293 K1 | NS 1 30 00 | 6LB005389-001 | | |

HINO

| | | | | | | | |
|------------|------------|-----------|------------|------------|------------|------------|------------|
| NS 441 00 | 26964 | NS 814 02 | 77320-1360 | NS 8 14 02 | 77320-1362 | NS 8 11 02 | 77320-1362 |
| NS 450 00 | 22829 | NS 814 02 | 14627 | NS 8 14 03 | 77320-1040 | NS 8 14 03 | 77320-1360 |
| NS 8 11 02 | 14627 | NS 814 03 | 14627 | NS 8 11 02 | 77320-1040 | NS 8 14 03 | 77320-1362 |
| NS 8 14 02 | 77320-1040 | NS 838 04 | 28754 | NS 8 11 02 | 77320-1360 | | |

HIDROMEK

| | | | | | | | |
|-----------|-----------------|-----------|-----------------|------------|---------------|---------------|----------------|
| NS 101 13 | 3480021 01 | NS 425 00 | 000HF 554/00630 | NS 8 43 05 | HF99/15017 | NS 9 25 01 | 000H F99/60270 |
| NS 101 13 | 000HF 348002101 | NS 425 00 | 554/00630 | NS 8 43 09 | 000F99/15018 | NS 9 25 01 | F99/60270 |
| NS 105 12 | 000H 520/081 12 | NS 822 00 | F99/00705 | NS 8 43 10 | 000F99/15020 | NS 9 25 04 | F9960260 |
| NS 105 12 | 520/081 10 | NS 822 01 | F99/00705 | NS 8 48 03 | 000HF99/15023 | NS 9 45 02 | 000S91/00658 |
| NS 105 12 | 520/081 12 | NS 822 04 | 000HF 99/00705 | NS 8 48 06 | 000HF99/15023 | NS 9 45 03 | 000S91/00657 |
| NS 105 26 | 000H 520/081 10 | NS 837 12 | 99/15019 | NS 9 22 21 | M114207100 | NS B 1 0000 1 | 000F 28/35500 |
| NS 133 01 | 520/811 1 | NS 843 05 | 000F99/15020 | NS 9 22 22 | M116102700 | NS B 1 0000 1 | 000F28/35500 |

| ISUZU | | | | | | | |
|------------|-----------------|-----------|---------------|----------|--------------|-------------|--------------|
| NS 65005 | 377776621001 | NS 435 00 | 8-94156-821-0 | NS 52415 | 377778218001 | NS 83000 | 387003261001 |
| NE 4002 12 | 387041639001 | NS 435 00 | 9-8275-0619-0 | NS 52431 | 387027396001 | NS 83000/1 | 387019630001 |
| NE 4002 13 | 387034012101 | NS 435 00 | 9-9412-0250-0 | NS 53710 | 387029929001 | NS 83000/2 | 387019630001 |
| NE 5017 | 387041255001 | NS 523 22 | 389990592051 | NS 53712 | 387029928001 | NS 837 18 | 387035267001 |
| NS 21800 | 894236910 | NS 524 02 | 377778221001 | NS 53714 | 387027398001 | NS 843 20 | 387037745001 |
| NS 26503 | 387041273001 | NS 524 13 | 7631710 | NS 53715 | 387033625001 | NS 84500 | 387009415101 |
| NS 30100 | 8-9707299470-51 | NS 524 13 | 15456024 | NS 65006 | 377776621001 | NS 86500 | 387038801001 |
| NS 31900 | 9-48418-21 | NS 524 13 | 5021170115 | NS 71000 | 377771125001 | NS 97600 01 | 388882750201 |
| NS 33700 | 9-48418-21 | NS 524 13 | 37778219001 | NS 71003 | 377771125001 | NS 97601 | 388883114001 |
| NS 42500 | 387027404001 | NS 524 13 | 377778219001 | NS 83000 | 377770735001 | NS B 1048 | 387008863001 |
| NS 43500 | 5-8244-0015-0 | NS 524 14 | 377778220001 | NS 83000 | 377776437001 | NS B 2193 | 387040564001 |

| IVECO | | | | | | | |
|----------|--------------|-----------|------------|----------|------------|----------|-----------|
| NS 30900 | 4249594 | NS 844 22 | 41298640 | NS 81400 | 500302656 | NS 84305 | 4821320-B |
| NS 44100 | 93190310 | NS 844 22 | 42541005 | NS 81400 | 42124439-Y | NS 84401 | 2993918 |
| NS 44500 | 93192483 | NS 844 22 | 500043667 | NS 81401 | 2534687 | NS 84401 | 2993922 |
| NS 44900 | 42047142 | NS 844 22 | 500302656 | NS 81401 | 2993918 | NS 84401 | 41042635 |
| NS 52302 | 3416590 | NS 847 02 | 41298161 | NS 81401 | 500302656 | NS 84401 | 41042787 |
| NS 52303 | 42331528 | NS 847 02 | 41298191 | NS 81401 | 42124439-Y | NS 84401 | 41298640 |
| NS 52317 | 2462473 | NS 847 02 | 41298639 | NS 82200 | 2993920 | NS 84401 | 42541005 |
| NS 52317 | 2495227 | NS 856 00 | 1369849 | NS 82200 | 4821320-B | NS 84401 | 500043667 |
| NS 52317 | 2607127 | NS 856 00 | 1402004 | NS 82201 | 2993920 | NS 84401 | 500302656 |
| NS 52317 | 3477035 | NS 856 00 | 1432187 | NS 82201 | 4821320-B | NS 84404 | 2993918 |
| NS 52400 | 1173173 | NS 803 01 | 40291 | NS 85600 | 2993918 | NS 84404 | 2993922 |
| NS 52401 | 9441014004 | NS 803 01 | 2993920 | NS 85600 | 2993922 | NS 84404 | 41042635 |
| NS 52402 | 2492526 | NS 803 01 | 98497961 | NS 85600 | 4716030 | NS 84404 | 41042787 |
| NS 52413 | 3435125 | NS 803 01 | 4821320-B | NS 85600 | 41042635 | NS 84404 | 41298640 |
| NS 52414 | 9441014004 | NS 803 02 | 40291 | NS 85600 | 41042787 | NS 84404 | 42541005 |
| NS 52415 | 2494278 | NS 803 02 | 2993920 | NS 85600 | 41298640 | NS 84404 | 500043667 |
| NS 52415 | 60120686 | NS 803 02 | 98497961 | NS 85600 | 42541005 | NS 84404 | 500302656 |
| NS 52415 | 8010000462MO | NS 803 02 | 4821320-B | NS 85600 | 500043667 | NS 84422 | 2993918 |
| NS 52415 | 97136134EZ | NS 803 03 | 40291 | NS 85600 | 500302656 | NS 84422 | 2993922 |
| NS 55100 | 73127291 | NS 803 03 | 2993920 | NS 85800 | 1369849 | NS 84422 | 41042635 |
| NS 55100 | 76008494 | NS 803 03 | 98497961 | NS 85800 | 1402004 | NS 85800 | 1432187 |
| NS 55101 | 3416621 | NS 803 03 | 4821320-B | NS 83711 | 41298191 | NS 85800 | 2993918 |
| NS 65005 | 46975 | NS 804 00 | 2993918 | NS 83718 | 41298191 | NS 85800 | 2993922 |
| NS 65005 | 3431319 | NS 811 00 | 2534687 | NS 83804 | 2993923 | NS 85800 | 4716030 |
| NS 65005 | 4822229 | NS 811 00 | 2993918 | NS 83804 | 190437010 | NS 85800 | 41042635 |
| NS 65006 | 46975 | NS 811 00 | 500302656 | NS 83905 | 40291 | NS 85800 | 41042787 |
| NS 65006 | 3431319 | NS 811 00 | 42124439-Y | NS 83905 | 41042786 | NS 85800 | 41298640 |
| NS 65006 | 4822229 | NS 814 00 | 2534687 | NS 83905 | 60183762 | NS 85800 | 42541005 |
| NS 65500 | 4822229 | NS 814 00 | 2993918 | NS 84305 | 40291 | NS 85800 | 500043667 |
| NS 84422 | 41042787 | NS 843 05 | 40291-F | NS 85800 | 500302656 | | |

| JCB | | | | | | | |
|----------|----------|-----------|----------|----------|-----------|----------|-----------|
| NS 10300 | 70102600 | NS 103 17 | 70703200 | NS 10328 | 70102600 | NS 40801 | 71301900 |
| NS 10300 | 70703200 | NS 103 17 | 70707500 | NS 10328 | 70703200 | NS 83712 | 332/H9719 |
| NS 10300 | 70707500 | NS 103 17 | 71005100 | NS 10328 | 70707500 | NS 83712 | 333/C0880 |
| NS 10300 | 71005100 | NS 103 25 | 70102600 | NS 10328 | 71005100 | NS 83727 | 332/F4780 |
| NS 10307 | 70703200 | NS 103 25 | 70703200 | NS 10328 | BAU2007 | NS 83727 | 332/F8215 |
| NS 10317 | 70102600 | NS 103 25 | 70707500 | NS 22600 | TS1587 | NS 83727 | 332/G0879 |
| NS 10325 | 71005100 | NS 408 00 | 71301900 | NS 83727 | 332/G9382 | | |

| JOHN DEERE | | | | | | | |
|------------|---------|-----------|---------|----------|----------|----------|----------|
| NS 80301 | AL34678 | NS 104 00 | AL36365 | NS 22301 | AL24527 | NS 52324 | AL17696 |
| NS 80301 | AT20911 | NS 104 00 | AL62707 | NS 22301 | AZ15473 | NS 52324 | AL27809 |
| NS 80302 | AL34678 | NS 124 00 | AL19890 | NS 22301 | DE12465 | NS 52324 | AL67715 |
| NS 80302 | AT20911 | NS 124 02 | AL19890 | NS 22301 | RE515494 | NS 52324 | AR45317 |
| NS 80303 | AL34678 | NS 124 03 | AL19890 | NS 22301 | RE51774 | NS 65005 | AL68661 |
| NS 80303 | AT20911 | NS 124 03 | AL32905 | NS 30100 | AR27977 | NS 65006 | AL68661 |
| NS 82200 | AL34678 | NS 124 03 | AL35864 | NS 30102 | AR27977 | NS 65200 | AZ39127 |
| NS 82201 | AL34678 | NS 124 04 | AL19890 | NS 30102 | AT85174 | NS 83712 | AL113086 |
| NS 84305 | AL34678 | NS 124 04 | AL32905 | NS 33000 | AR27977 | NS 83712 | AL113087 |
| NS 10400 | AL25064 | NS 124 04 | AL35864 | NS 33000 | AT18716 | NS 83712 | AL78343 |
| NS 10400 | AL30561 | NS 134 01 | AL23512 | NS 33000 | AT27977 | NS 83712 | AL80633 |
| NS 10400 | AL32903 | NS 134 02 | AL23512 | NS 33000 | AT85174 | NS 84312 | AL34678 |

**KARSAN**

| | | | | | | | |
|----------------|------------------------|-------------|-----------------------|--------------|-----------------------|----------------|-----------------------|
| NE 4003 03 | KR.MXLO 1.731.P0001 | NS 140 06 | KR.CSX01.75 2P0001-YP | NS 5 34 01 | 178921_L | NS 9 25 04 | KR.CSX01.514 P0032 |
| NE 4003 04 | KR.CSX01.73 1.P0001 | NS 144 00 | 2001859 6011 | NS 5 34 02 | 178995_L | NS 9 36 00 | 20018593 169-YP |
| NE 4008 00 | KR.CXLO1.731P010 | NS 144 00/1 | 2001859 6011/1 | NS 5 34 06 | KR.B1801.131P0113 | NS 9 36 00 | F.2 0018593169 |
| NE 4008 01 | KR.CSX01.73 4P0009 | NS 194 00 | 2001859 6013 | NS 6 52 00 | KR.CSX01.724 P0003 | NS 9 37 00 | 20018594 403 |
| NE 4008 11 | KR.CSX01.37 3P0139 | NS 195 00 | 2001859 6012 | NS 6 52 00-K | Devre Kesici | NS 9 37 05 | KR.CSX01.372 P0061 |
| NE 4008 20 | KR.CXLO1.731P011 | NS 195 02 | 2001859 4932 | NS 6 52 03 | KR.CSX01.724 P0003 | NS 9 37 05 | KR.CSX01.372 P0061-YP |
| NE 4008 21 | KR.CSX01.73 4P0008 | NS 2177 | KR.CSX01.75 2A0000 | NS 6 55 00 | KR.CXLO1.724P00 03 | NS 9 46 05 | KR.CSX01.373 P0007 |
| NE 5011 | 2001859 4277 | NS 419 00 | 2001859 5347 | NS 7 10 00 | KR.B1801.131P0034 | NS 9 46 05 | KR.CSX01.373 P0007-YP |
| NE 5013 | KR.CSX01.73 0A0007 | NS 419 00 | 2001859 5347-YP | NS 8 26 00 | 20011859 3086 | NS 9 46 10 | KR.CSX01.373 P0136 |
| NE 5013 | KR.CSX01.73 0A0007-YP | NS 419 07 | 2001859 5348 | NS 8 26 02 | 20018593 086 | NS 9 49 00 | 20018591 012 |
| NE 5014 | KR.CXLO1.731A0011 | NS 419 07 | 2001859 5348-YP | NS 8 26 02 | 20018593 086-YP | NS 9 49 01 | 20018591 006 |
| NE 5014 | KR.CXLO1.731A0011-YP | NS 419 08 | KR.MXLO 1.731P0013 | NS 8 51 07 | KR.CSX01.131 P0005 | NS 9 59 04 | 20018594 982 |
| NE 5015 | KR.MXLO 1.731A001 1 | NS 425 00 | 2001859 4122 | NS 8 51 07 | KR.CSX01.131 P0005-YP | NS 9 59 05 | 20018594 981 |
| NE 5015 | KR.MXLO 1.731A001 1-YP | NS 429 00 | 5097833 | NS 9 22 23 | KR.CSX01.375 A0023 | NS 9 59 05 | 20018594 981-YP |
| NS 1 015 0 0 | 2001859 4276-YP | NS 429 00 | 8421906 4 | NS 9 22 24 | KR.CSX01.443 A0009 | NS 9 76 00 | KR.CSX01.375 P0024 |
| NS 1 015 0 1 | 2001859 4277 | NS 429 00 | 5097833-YP | NS 9 22 27 | KR.CXLO1.531A0005 | NS B 1 015 | 20018594 276 |
| NS 1 400 5 | 2001859 6011 | NS 429 01 | 8766097 8-YP | NS 9 22 28 | KR.CXLO1.533A0005 | NS B 1 015 0 1 | 20018594 277 |
| NS 1 400 5 | 2001859 6011-YP | NS 523 18 | P.70144 | NS 9 22 29 | KR.CXLO1.537A0008 | NS B 1 062 0 1 | KR.CSX01.131 P0048 |
| NS 1 400 5 0 1 | NS 140 05 0 1 | NS 523 19 | KR.CXLO1.266P0 318 | NS 9 23 00 | KR.CSX01.372 P0051 | NS B 1 062 0 2 | KR.CSX01.131 P0049 |
| NS 1 400 6 | KR.CSX01.75 2P0001 | NS 524 37 | KR.CXLO1.266P0 020 | NS 9 23 00 | KR.CSX01.375 P0051-YP | NS B 2 156 | 20018593 204 |

LEYLAND / DAF

| | | | | | | | |
|----------|---------|-----------|---------|------------|---------|------------|---------|
| NS 10100 | BMK1411 | NS 103 17 | 37H8530 | NS 1 03 28 | BAU2007 | NS 4 08 01 | 13H2024 |
| NS 10300 | 37H8530 | NS 103 25 | 37H8530 | NS 1 05 00 | BMK1411 | NS 5 23 03 | FBU1234 |
| NS 10305 | 37H8530 | NS 103 28 | 37H8530 | NS 4 08 00 | 13H2024 | NS 8 34 00 | ATJ3092 |
| NS 10307 | 13H1072 | NS 103 07 | 83H1072 | | | | |

LUCAS

| | | | | | | | |
|------------|-------|-----------|-------|------------|--------|------------|---------|
| NS 1 05 39 | 1285A | NS 103 08 | 35648 | NS 1 08 02 | 33714 | NS 4 14 00 | SMB499 |
| NS 10100 | 33884 | NS 103 17 | 33820 | NS 1 08 02 | 34592 | NS 4 37 00 | SMB428 |
| NS 10100 | 35703 | NS 103 17 | 34228 | NS 1 27 03 | 35589 | NS 5 23 25 | SMB426 |
| NS 10106 | 35288 | NS 103 17 | 35641 | NS 1 27 06 | 35327 | NS 6 50 05 | SSB1 11 |
| NS 10300 | 33820 | NS 103 17 | 35670 | NS 1 27 10 | 30811 | NS 6 50 06 | SSB1 11 |
| NS 10300 | 34228 | NS 103 25 | 33820 | NS 1 27 10 | 36614 | NS 6 52 00 | SSB1 13 |
| NS 10300 | 35641 | NS 103 25 | 34228 | NS 1 27 12 | 30634 | NS 7 20 00 | SRB346 |
| NS 10300 | 35670 | NS 103 25 | 35641 | NS 1 27 12 | 30634 | NS 7 20 01 | SRB346 |
| NS 1 03 03 | 35589 | NS 103 28 | 33820 | NS 3 01 00 | SOB103 | NS 7 21 00 | 76464 |
| NS 1 03 04 | 33940 | NS 103 28 | 34228 | NS 3 03 00 | OPS106 | NS 7 21 00 | 76722 |
| NS 10305 | 33942 | NS 103 28 | 35641 | NS 3 03 00 | SOB200 | NS 7 21 00 | 76766 |
| NS 10306 | 35327 | NS 105 00 | 33884 | NS 3 03 00 | SOB201 | NS 7 21 00 | SRB325 |
| NS 10307 | 35628 | NS 105 00 | 35703 | NS 4 06 02 | SMB485 | NS 7 21 01 | SRB325 |
| NS 10308 | 31854 | NS 108 00 | 33714 | NS 4 07 00 | SMB497 | NS 7 21 03 | 6958 |
| NS 10308 | 34501 | NS 108 00 | 34592 | NS 4 07 01 | SMB484 | NS 7 21 03 | SRB333 |
| NS 10308 | 35630 | | | | | | |

MAN

| | | | | | | | |
|------------|--------------|-----------|-----------------|------------|--------------|------------|---------------|
| NS 5 51 01 | 9081616 0570 | NS 524 14 | 8125521 6019 | NS 8 58 00 | 81122106 027 | NS 4 50 00 | 81255050 794 |
| NS 6 50 05 | 8125506 7000 | NS 524 15 | 1011016 535 | NS 8 11 00 | 81122100 033 | NS 4 62 00 | 81255050 930 |
| NS 6 50 05 | 9081616 0511 | NS 551 00 | 8125505 0237 | NS 8 11 00 | 81122100 036 | NS 5 23 00 | 81255216 004 |
| NS 6 50 06 | 8125506 7000 | NS 651 00 | 8125506 6037 | NS 8 11 00 | 81122100 037 | NS 5 23 02 | 81225200 021 |
| NS 6 50 06 | 9081616 0511 | NS 651 00 | 8125506 6120 | NS 8 11 00 | 81122100 038 | NS 5 23 02 | 81255200 010 |
| NS 8 03 01 | 8112210 7006 | NS 652 00 | 8125506 6005 | NS 8 11 00 | 81122100 040 | NS 5 23 02 | 85255200 021 |
| NS 8 03 02 | 8112210 7006 | NS 710 00 | 8112225 0013 | NS 8 11 00 | 81122100 041 | NS 5 23 02 | 81122520 6006 |
| NS 8 03 03 | 8112210 7006 | NS 811 00 | 8112210 0015 | NS 8 11 00 | 81122100 053 | NS 5 23 03 | 88255216 210 |
| NS 8 04 00 | 8112210 6014 | NS 844 22 | 8112201 7003 | NS 8 11 00 | 81122100 057 | NS 5 23 17 | 81255216 009 |
| NS 8 44 01 | 8112201 7003 | NS 844 22 | 8112210 0036 | NS 8 11 00 | 81122106 014 | NS 5 23 22 | 81255050 673 |
| NS 8 44 01 | 8112210 0036 | NS 844 22 | 8112210 0038 | NS 8 11 00 | 81122106 025 | NS 8 14 00 | 81122100 041 |
| NS 8 44 01 | 8112210 0038 | NS 844 22 | 8112210 6014 | NS 8 14 00 | 81122100 015 | NS 8 14 00 | 81122100 053 |
| NS 8 44 01 | 8112210 6014 | NS 844 22 | 8112210 6027 | NS 8 14 00 | 81122100 033 | NS 8 14 00 | 81122100 057 |
| NS 8 44 01 | 8112210 6027 | NS 856 00 | 8112201 7003 | NS 8 14 00 | 81122100 036 | NS 8 14 00 | 81122106 014 |
| NS 8 44 04 | 8112201 7003 | NS 856 00 | 81.122.017.00 3 | NS 8 14 00 | 81122100 037 | NS 8 14 00 | 81122106 025 |
| NS 8 44 04 | 8112210 0036 | NS 856 00 | 8112210 0036 | NS 8 14 00 | 81122100 038 | NS 8 14 01 | 81122100 015 |
| NS 8 44 04 | 8112210 0038 | NS 856 00 | 8112210 0038 | NS 8 14 00 | 81122100 040 | NS 8 14 01 | 81122100 033 |
| NS 8 44 04 | 8112210 6014 | NS 856 00 | 81.122.100.03 8 | NS 8 66 01 | 81154026 027 | NS 8 14 01 | 81122100 036 |
| NS 8 44 04 | 8112210 6027 | NS 856 00 | 8112210 6014 | NS 8 66 02 | 81154026 027 | NS 8 14 01 | 81122100 037 |
| NS 5 23 22 | 8125505 0763 | NS 856 00 | 8112210 6027 | NS 8 66 03 | 81154026 027 | NS 8 14 01 | 81122100 038 |
| NS 5 24 00 | 8425521 6032 | NS 858 00 | 8112201 7003 | NS 4 41 00 | 81255200 050 | NS 8 14 01 | 81122100 040 |

MAN

| | | | | | | | |
|----------|--------------|-----------|-----------------|-----------|--------------|-----------|--------------|
| NS 52401 | 8125521 6013 | NS 858 00 | 81.122.017.003 | NS 442 00 | 81255050 538 | NS 8 1401 | 81122100 041 |
| NS 52401 | 8125521 6019 | NS 858 00 | 81122100 036 | NS 442 00 | 81255050 808 | NS 8 1401 | 81122100 053 |
| NS 52408 | 8825521 6207 | NS 858 00 | 81122100 038 | NS 442 00 | 81274210 056 | NS 8 1401 | 81122100 057 |
| NS 52412 | 8125521 6032 | NS 858 00 | 81.122.100.03 8 | NS 449 00 | 81255050 461 | NS 8 1401 | 81122106 014 |
| NS 52413 | 8825521 6208 | NS 858 00 | 8112210 6014 | NS 450 00 | 81255050 461 | NS 8 1401 | 81122106 025 |
| NS 52414 | 8125521 6013 | | | | | | |

MASSEY FERGUSON (AGCO)

| | | | | | | | |
|-----------|---------------|--------------|---------------|-----------|--------------|---------------|-------------|
| NS 10106 | 2846129 | NS 303 00 | 1856097 M91 | NS 108 00 | 1699034M1 | NS 112 00 | 881670M1 |
| NS 1021 | 002180U9 2M | NS 303 00 | 273541M91 | NS 108 00 | 1699034M91 | NS 113 00 | 881670M1 |
| NS 1023 | 3578411 7 | NS 303 00 | 508692M91 | NS 108 02 | 1668816M1 | NS 127 03 | 2846119 |
| NS 1023 | 002183U9 2M | NS 304 02 | 2918342 M2 | NS 108 02 | 1668816M2 | NS 127 03 | 846383M91 |
| NS 1023 | 4224518 M91 | NS 407 00 | 1692877 | NS 408 00 | 3761983M91 | NS 128 00 | 4292836M2 |
| NS 103 00 | 1865976 | NS 407 00 | 1833740 | NS 408 00 | 3813850M91 | NS 133 00 | 3696292M91 |
| NS 103 00 | 1097239 M91 | NS 407 00 | 1012043 M91 | NS 408 01 | 1693818M1 | NS 133 00 | 3699292M92 |
| NS 103 00 | 1287453 5V3 | NS 407 00 | 1012045 3M91 | NS 408 01 | 3598530M1 | NS 133 00 | 3699692M91 |
| NS 103 00 | 1446116 M1 | NS 407 00 | 1679223 M1 | NS 408 01 | 3697346M1 | NS 133 02 | 3699292M92 |
| NS 103 00 | 1446116 M91 | NS 407 00 | 1687049 M92 | NS 408 01 | 3697346M91 | NS 133 02 | 3699692M91 |
| NS 103 00 | 1690093 M91 | NS 407 00 | 3381094 M1 | NS 408 01 | 3761983M91 | NS 133 02 | 3699692M92 |
| NS 103 00 | 1874120 M91 | NS 407 00 | 888501M2 | NS 409 00 | 1696842M1 | NS 183 00 | 1668830M91 |
| NS 103 00 | 1874120 M93 | NS 407 00 | 961417M2 | NS 409 00 | 3759508M91 | NS 191 00 | 1671544M1 |
| NS 103 00 | 1874120 T94 | NS 407 00 | 963417M2 | NS 410 00 | 0017143U 91 | NS 191 00 | 1682977M1 |
| NS 103 00 | 1874123 0M93 | NS 407 00/ 1 | 1679223 M2 | NS 417 00 | 00113886 U92 | NS 207 00 | 1825118M91 |
| NS 103 00 | 1874535 M3 | NS 408 00 | 1693818 M1 | NS 417 01 | 0017373U 91 | NS 207 00 | 1877731M92 |
| NS 103 00 | 3547633 M91 | NS 408 00 | 3598530 M1 | NS 423 00 | 3763601M1 | NS 207 00 | 1877731M93 |
| NS 103 03 | 2846119 | NS 408 00 | 3697346 M1 | NS 424 00 | 3698225M1 | NS 207 00 | 1877731T92M |
| NS 103 03 | 846383M91 | NS 408 00 | 3697346 M91 | NS 424 00 | 3698425M1 | NS 207 00 | 922119M1 |
| NS 103 04 | 1690093 | NS 103 17 | 1874120 M93 | NS 424 00 | 3763719M1 | NS 207 00 | 963418M1 |
| NS 103 04 | 1859505 | NS 103 17 | 1874120 T94 | NS 424 00 | 3763720M1 | NS 207 00 | 969606M2 |
| NS 103 04 | 1895105 M1 | NS 103 17 | 1874123 0M93 | NS 436 00 | 1647989M1 | NS 207 01 | 1825118M91 |
| NS 103 05 | 1874120 M91 | NS 103 17 | 1874535 M3 | NS 437 00 | 1424104M92 | NS 207 01 | 1877731M92 |
| NS 103 05 | 1874120 M93 | NS 103 17 | 3547633 M91 | NS 438 00 | 1833739M1 | NS 207 01 | 1877731M93 |
| NS 103 05 | 1874535 M1 | NS 103 23 | 0011224 3U91 | NS 528 00 | 1687046M1 | NS 710 01 | 0015777U 2 |
| NS 103 05 | 1874535 M3 | NS 103 23 | 3779699 M | NS 528 00 | 1693367M1 | NS 710 01 | 0015777U 2M |
| NS 103 05 | 1874535 M39 | NS 103 24 | 1874120 T93 | NS 533 00 | 3595186M2 | NS 821 05 | 002601U9 1 |
| NS 103 05 | 504809M91 | NS 103 25 | 1865976 | NS 533 00 | 3595186T2 | NS 829 00 | 002176U9 1M |
| NS 103 05 | 883928M91 | NS 103 25 | 1097239 M91 | NS 533 00 | 3598510M1 | NS 829 00 | 1097239M |
| NS 103 08 | 504809M91 | NS 103 25 | 1287453 5V3 | NS 561 62 | 0014742U 1 | NS 834 00 | 0012409U 91 |
| NS 103 08 | 883920M1 | NS 103 25 | 1446116 M1 | NS 561 72 | 0019867U 1 | NS 834 00 | 001584U9 1 |
| NS 103 08 | 883928M1 | NS 103 25 | 1446116 M91 | NS 601 00 | 1604409M1 | NS 834 00 | 1666439M91 |
| NS 103 08 | 883928M91 | NS 103 25 | 1690093 M91 | NS 601 00 | 1682977M1 | NS 834 00 | 1698042M91 |
| NS 103 08 | 963416M1 | NS 103 25 | 1874120 M91 | NS 601 00 | 1687049M92 | NS 834 00 | 1876534M91 |
| NS 103 08 | 967570M4 | NS 103 25 | 1874120 M93 | NS 601 00 | 1874709M1 | NS 834 00 | 828583M91 |
| NS 103 17 | 1865976 | NS 103 25 | 1874120 T94 | NS 601 00 | 961978M1 | NS 834 00 | 963023M2 |
| NS 103 17 | 1097239 M91 | NS 103 25 | 1874120 T94 M | NS 650 05 | 3613598M91 | NS 837 01 | 3786050M1 |
| NS 103 17 | 1287453 5V3 | NS 103 25 | 1874123 0M93 | NS 650 06 | 3613598M91 | NS 837 12 | 00114455 U1 |
| NS 103 17 | 1446116 M1 | NS 103 25 | 1874535 M3 | NS 710 01 | 0015777U 1 | NS 837 12 | 3786050M1 |
| NS 103 17 | 1446116 M91 | NS 103 25 | 3547633 M91 | NS 108 02 | 1668816M91 | NS 837 12 | 4274363M1 |
| NS 103 17 | 1690093 M91 | NS 103 28 | 1865976 | NS 108 02 | 1699034M1 | NS 843 12 | 1695732M1 |
| NS 103 17 | 1874120 M91 | NS 103 28 | 1097239 M91 | NS 108 02 | 1699034M91 | NS 843 12 | 3697463M1 |
| NS 207 01 | 1877731 T92 M | NS 103 28 | 1287453 5V3 | NS 108 04 | 54033364 | NS 946 00 | 12051 |
| NS 207 01 | 922119M1 | NS 103 28 | 1446116 M1 | NS 108 04 | 882283M1 | NS 948 00 | 0012050U 1 |
| NS 207 01 | 963418M1 | NS 103 28 | 1446116 M91 | NS 109 02 | 2486119 | NS 948 01 | 0012050U 1 |
| NS 207 01 | 969606M2 | NS 103 28 | 1690093 M91 | NS 109 02 | 3763601 | NS B 1 021 | 002180U9 2 |
| NS 223 00 | 3812023 M1 | NS 103 28 | 1874120 M91 | NS 109 02 | 0013598U 91 | NS B 1 021 01 | 002409U9 1 |
| NS 256 00 | 3595187 M1 | NS 103 28 | 1874120 M93 | NS 111 01 | 882283M1 | NS B 1 022 | 002182U9 2 |
| NS 256 00 | 3595187 T1 | NS 103 28 | 1874120 T94 | NS 111 06 | 00882283 M1 | NS B 1 023 | 002183U9 2 |
| NS 301 00 | 530933 | NS 103 28 | 1874120 T94 M | NS 111 06 | 882283M1 | NS B 1 024 | 002338U9 1 |
| NS 301 00 | 1725197 2 | NS 103 28 | 1874123 0M93 | NS 111 06 | 899339M1 | NS B 1 025 | 002339U9 1 |
| NS 301 00 | 1423895 M91 | NS 103 28 | 1874535 M3 | NS 112 00 | 1672755 | NS B 1 025 01 | 002444U9 1 |
| NS 301 00 | 1833647 M1 | NS 103 28 | 3547633 M91 | NS 112 00 | 1682977 | NS B 1 026 | 002470U9 1 |
| NS 301 00 | 1877721 M1 | NS 103 45 | 5732553200 | NS 112 00 | 001565U1 | NS B 1 026 01 | 002480U9 1 |
| NS 301 00 | 1877721 M92 | NS 108 00 | 1668816 M1 | NS 112 00 | 001565U1 M | NS B 1 027 03 | 0015144U 2 |
| NS 301 00 | 3599307 M91 | NS 108 00 | 1668816 M2 | NS 112 00 | 1881670M1 | NS B 1 027 04 | 0015268U 1 |
| NS 301 00 | 3599307 T91 | NS 108 00 | 1668816 M91 | NS 112 00 | 3101795M1 | NS B 1 028 03 | 0015776U 1 |

**MERCEDES**

| | | | | | | | |
|------------|--------------|-----------|--------------|------------|--------------|------------|--------------|
| NS 13000 | 0005454 104 | NS 446 00 | 0005454 909 | NS 5 51 00 | 00054522 09 | NS 8 44 04 | 4718430 |
| NS 13000 | 0005456 604 | NS 446 00 | 0005455 409 | NS 5 51 00 | 00054561 09 | NS 8 44 04 | A0 004700305 |
| NS 19405 | 0025406 244 | NS 446 00 | 0005458 009 | NS 5 51 00 | 00154508 09 | NS 8 44 04 | A0 004700405 |
| NS 4 43 00 | 330458 | NS 446 00 | 3645457 309 | NS 6 52 00 | A0 005452508 | NS 8 44 04 | A0 004701230 |
| NS 4 43 00 | 0015452 909 | NS 447 00 | 0038876 210 | NS 6 52 00 | A0 005454908 | NS 8 44 04 | A0 004716030 |
| NS 4 44 00 | 41130 | NS 447 00 | 0038890 13 | NS 6 52 00 | A0 005455808 | NS 8 44 22 | 4700105 |
| NS 4 44 00 | 0005457 009 | NS 449 00 | 0015457 714 | NS 6 52 00 | A0 005458408 | NS 8 44 22 | 4711230 |
| NS 8 04 00 | 4716730 | NS 450 00 | 0015451 614 | NS 6 52 00 | A0 005459708 | NS 8 44 22 | 4716730 |
| NS 8 11 00 | 0004700 405 | NS 450 00 | 0015454 414 | NS 8 14 00 | 30247101 30 | NS 8 44 22 | 4718430 |
| NS 8 11 00 | 0004711 230 | NS 453 00 | 0045452 714 | NS 8 14 00 | 37147072 05 | NS 8 44 22 | A0 004700305 |
| NS 8 11 00 | 0004716 730 | NS 460 00 | 0015451 809 | NS 8 14 00 | 00047004 05 | NS 8 44 22 | A0 004700405 |
| NS 8 11 00 | 3024710 130 | NS 444 00 | F18.043 | NS 8 14 00 | 00047112 30 | NS 8 44 22 | A0 004701230 |
| NS 8 11 00 | 3714707 205 | NS 445 00 | 0005456 106 | NS 8 14 00 | 00047167 30 | NS 8 44 22 | A0 004716030 |
| NS 8 66 01 | 4701805 | NS 523 25 | 0005456 509 | NS 8 14 01 | 30247101 30 | NS 8 56 00 | 4700105 |
| NS 8 66 01 | 4702705 | NS 524 12 | A0007634210 | NS 8 14 01 | 37147072 05 | NS 8 56 00 | 4711230 |
| NS 8 66 01 | 4704105 | NS 534 01 | 3445457 214 | NS 8 14 01 | 00047004 05 | NS 8 56 00 | 4716730 |
| NS 8 66 02 | 4701805 | NS 534 01 | 0005455 414 | NS 8 14 01 | 00047112 30 | NS 8 56 00 | 4718430 |
| NS 8 66 02 | 4702705 | NS 537 00 | 0045458 614 | NS 8 14 01 | 00047167 30 | NS 8 56 00 | A0 004700305 |
| NS 8 66 02 | 4704105 | NS 460 00 | 0015454 909 | NS 8 39 05 | A4 404700105 | NS 8 56 00 | A0 004700405 |
| NS 8 66 03 | 4701805 | NS 460 00 | 0015458 409 | NS 8 44 01 | 4700105 | NS 8 56 00 | A0 004701230 |
| NS 8 66 03 | 4702705 | NS 460 01 | 1545160 9 | NS 8 44 01 | 4711230 | NS 8 56 00 | A0 004716030 |
| NS 8 66 03 | 4704105 | NS 460 01 | 1545460 9 | NS 8 44 01 | 4716730 | NS 8 58 00 | 4700105 |
| NS 1 34 01 | A0005456017 | NS 460 01 | 1545730 9 | NS 8 44 01 | 4718430 | NS 8 58 00 | 4711230 |
| NS 1 34 02 | A0005456017 | NS 460 01 | 1545730 9 | NS 8 44 01 | A0 004700305 | NS 8 58 00 | 4716730 |
| NS 3 02 00 | 0045452 614 | NS 462 00 | 0015451 709 | NS 5 51 01 | 00054546 09 | NS 8 58 00 | 4718430 |
| NS 3 02 01 | 4545261 4 | NS 462 00 | 0015454 709 | NS 5 51 01 | 00054565 09 | NS 8 58 00 | A0 004700305 |
| NS 3 04 01 | 5454317 | NS 462 00 | 0015457 409 | NS 6 50 05 | 00054525 08 | NS 8 58 00 | A0 004700405 |
| NS 3 04 01 | 8663386 5000 | NS 523 00 | A6717630610 | NS 6 50 05 | 00054584 08 | NS 8 58 00 | A0 004701230 |
| NS 3 04 02 | 5454317 | NS 523 02 | A007631410 | NS 6 50 06 | 00054525 08 | NS 8 58 00 | A0 004716030 |
| NS 3 04 02 | 8663386 5000 | NS 523 03 | 0007630410 | NS 6 50 06 | 00054584 08 | NS 9 53 00 | 60176005 9 |
| NS 4 41 00 | 0015454 214 | NS 523 03 | 0007630810 | NS 8 04 00 | 4711230 | NS 9 53 00 | 38176002 59 |
| NS 4 41 00 | 0015454 714 | NS 524 15 | 0045459 024 | NS 8 44 01 | A0 004700405 | NS 9 53 00 | 38176600 01 |
| NS 4 41 00 | 0015455 709 | NS 537 06 | 0045455 414 | NS 8 44 01 | A0 004701230 | NS 9 53 00 | 38176609 01 |
| NS 4 41 00 | 0015458 214 | NS 537 07 | 0045455 514 | NS 8 44 01 | A0 004716030 | NS 9 53 00 | 38189306 03 |
| NS 4 42 00 | 0015453 414 | NS 537 07 | 0065451 114 | NS 8 44 04 | 4700105 | NS 9 53 00 | 67076001 59 |
| NS 4 42 00 | 0015454 414 | NS 551 00 | 6001385 0100 | NS 8 44 04 | 4711230 | NS 9 53 00 | A6 887607059 |
| NS 4 42 00 | 0015456 414 | NS 551 00 | 0005450 109 | NS 8 44 04 | 4716730 | NS 9 62 00 | 31476605 01 |
| NS 4 42 00 | 0025458 114 | NS 442 00 | 0035451 614 | | | | |

MITSUBISHI

| | | | | | | | |
|------------|-----------|-----------|----------------|------------|--------------|------------|------------|
| NS 2 18 00 | MD-001380 | NS 319 00 | MD0 21567 | NS 3 37 00 | MD-001483 | NS 4 35 00 | MB-11 3081 |
| NS 2 18 00 | MD-603427 | NS 319 00 | MD-138994 | NS 3 37 00 | MD-017430 | NS 8 11 02 | MC013788 |
| NS 3 19 00 | MD-001481 | NS 337 00 | MC-84 0119.219 | NS 3 37 00 | MD-021566.67 | NS 8 14 02 | MC013788 |
| NS 3 19 00 | MD-001482 | NS 337 00 | MD-001481.82 | NS 3 37 00 | MD-138993 | NS 8 14 03 | MC013788 |
| NS 3 19 00 | MD-001483 | NS 319 00 | MD-017430 | | | | |

NATO

| | | | | | | | |
|------------|------------------|-----------|----------------|------------|------------------|------------|-------------------|
| NS 1 30 00 | 5930-12-166-0976 | NS 215 00 | 6685998 048679 | NS 6 50 05 | 5930-12-121-7993 | NS 6 52 00 | 85930-12-199-5291 |
| NS 1 01 06 | 5930997 978638 | NS 301 00 | 5930998 818223 | NS 6 50 06 | 5930-12-121-7993 | NS 7 21 00 | 59459980 96484 |
| NS 1 03 04 | 5930992 550732 | NS 523 02 | 5930121 614717 | | | | |

NEOPLAN

| | | | | | | | |
|------------|-------------|-----------|-----------------|------------|-----------------|------------|----------------|
| NS 5 23 02 | 1102782 00 | NS 524 02 | 2406181 00 | NS 5 24 12 | 11027235 465/10 | NS 5 24 14 | 11027225 46503 |
| NS 5 23 03 | 1104739 8 | NS 524 02 | 1102581 5437/51 | NS 5 24 14 | 1132028 | NS 5 24 15 | 11016535 |
| NS 5 23 03 | 2403167 000 | NS 524 12 | 1102585 00 | NS 5 24 14 | 11017512 | NS 5 24 15 | 10214060 0 |
| NS 5 23 17 | 1102788 10 | NS 524 12 | 1102582 5437/52 | NS 5 24 14 | 11027860 0 | NS 6 50 05 | 15063120 0 |
| NS 5 23 22 | 1102789 07 | NS 524 12 | 1102585 5437/78 | NS 5 24 14 | 73140160 00 | NS 6 50 06 | 15063120 0 |
| NS 5 24 01 | 1101751 2 | NS 524 01 | 1102786 00 | | | | |

NISSAN

| | | | | | | | |
|------------|-----------|-----------|-----------|------------|-----------|--|--|
| NS 8 11 02 | 1420001 4 | NS 814 02 | 1420001 4 | NS 8 14 03 | 1420001 4 | | |
|------------|-----------|-----------|-----------|------------|-----------|--|--|

OTOKAR

| | | | | | | | |
|------------|------------------|-----------|---------------------|------------|-----------------|------------|----------------|
| NS 1 42 04 | 13C7 4 363 38 AA | NS 406 02 | 71A00-3631 5-AA | NS 4 30 04 | 13C00-1705 4AA | NS 7 10 00 | 71C00-33260-AA |
| NS 1 67 00 | 12A14/76121/AA | NS 430 04 | OTK-13C00-1705 4-AA | NS 5 24 08 | 21C02-08170 0AA | NS 7 10 00 | 71C00-33260AA |
| NS 1 94 05 | 99000-43914-AA | | | | | | |

| PERKINS | | | | | | | |
|----------|---------|-----------|---------|----------|---------|----------|----------|
| NS 10300 | 2846121 | NS 103 05 | 2846130 | NS 10317 | 2846130 | NS 10328 | 2846121 |
| NS 10300 | 2846130 | NS 103 08 | 2846124 | NS 10325 | 2846121 | NS 10328 | 2846130 |
| NS 10305 | 2846121 | NS 103 17 | 2846121 | NS 10325 | 2846130 | NS 52302 | 82848073 |

| RENAULT | | | | | | | |
|----------|------------|-----------|------------|----------|------------|----------|------------|
| NS 81102 | 5001834430 | NS 309 00 | 855889300 | NS 52303 | 5010046407 | NS 84404 | 5010505905 |
| NS 81102 | 5001864551 | NS 309 00 | 7701365429 | NS 52317 | 0000719780 | NS 84422 | 5001864551 |
| NS 81402 | 5001834430 | NS 309 00 | 7701365430 | NS 52415 | 5430044135 | NS 84422 | 5001865160 |
| NS 81402 | 5001864551 | NS 309 00 | 7701655787 | NS 65005 | 7101010041 | NS 84422 | 5010505905 |
| NS 81403 | 5001834430 | NS 319 00 | 448414055 | NS 65006 | 7101010041 | NS 84702 | 7420926022 |
| NS 81403 | 5001864551 | NS 337 00 | 448414055 | NS 81100 | 5001834430 | NS 85300 | 5000787148 |
| NS 10100 | 005542300 | NS 441 00 | 5000788582 | NS 81100 | 5001864551 | NS 85300 | 5001832894 |
| NS 10106 | 000362847 | NS 442 00 | 5000788429 | NS 81400 | 5001834430 | NS 85300 | 5001834430 |
| NS 10500 | 5542300 | NS 460 00 | 5001845859 | NS 81400 | 5001864551 | NS 85300 | 5001856142 |
| NS 13401 | 5000081133 | NS 460 00 | 5001868473 | NS 81401 | 5001834430 | NS 85300 | 5001864551 |
| NS 13402 | 5000081133 | NS 460 00 | 7421318083 | NS 81401 | 5001864551 | NS 85600 | 5001864551 |
| NS 22200 | 600001355 | NS 460 00 | 7485116453 | NS 84401 | 5001864551 | NS 85600 | 5001865160 |
| NS 22200 | 7700503200 | NS 461 00 | 7421318089 | NS 84401 | 5001865160 | NS 85600 | 5010505905 |
| NS 22200 | 7701349086 | NS 523 02 | 5000080230 | NS 84401 | 5010505905 | NS 85800 | 5001864551 |
| NS 22200 | 7702002661 | NS 523 02 | 5000257029 | NS 84404 | 5001864551 | NS 85800 | 5001865160 |
| NS 30900 | 770166787 | NS 523 02 | 5000271900 | NS 84404 | 5001865160 | NS 85800 | 5010505905 |
| NS 30900 | 853621300 | NS 309 00 | 855822500 | | | | |

| SAAB | | | | | | | |
|----------|---------|-----------|---------|----------|---------|----------|---------|
| NS 30101 | 830440 | NS 309 00 | 9109182 | NS 30900 | 9112459 | NS 30300 | 8811374 |
| NS 30900 | 7522402 | | | | | | |

| SAME DF / ŞAHSUVAROĞLU / DEUTZ | | | | | | | |
|--------------------------------|---------|-----------|------------------|----------|-----------------|----------|---------------|
| NS 10338 | 0016011 | NS 134 02 | 1163920 | NS 30401 | 1111021 | NS 82105 | 002601U91 |
| NS 12403 | 1164422 | NS 134 02 | 1180133 | NS 30401 | 1172869 | NS 83500 | 892804 |
| NS 12403 | 1171411 | NS 134 02 | 276590370 | NS 30401 | 1180414 | NS 83500 | 0.008.9280.4 |
| NS 12403 | 1171442 | NS 204 01 | Y2.7099.640.0/10 | NS 40100 | 2.7649.050.0/11 | NS 83500 | Y.008.9280.4 |
| NS 12404 | 1164422 | NS 302 00 | 012579 | NS 65200 | 6261016 | NS 83600 | 0.012.3914.3 |
| NS 12404 | 1171411 | NS 302 00 | 2.7909360.0.0/10 | NS 65200 | 6262072 | NS 83600 | Y0.012.3914.3 |
| NS 12404 | 1171442 | NS 302 01 | 12579 | NS 80301 | 1244823 | NS 85102 | 0015077 |
| NS 13401 | 312044 | NS 302 01 | 12579 | NS 80302 | 1244823 | NS 85103 | 1560150 |
| NS 13401 | 1163920 | NS 302 01 | 2.7909360.0.0/10 | NS 80303 | 1244823 | NS 85105 | 1560150 |
| NS 13401 | 1180133 | NS 134 01 | 276590370 | NS 13402 | 312044 | | |

| SANKO / DAEWOO / MASTAŞ | | | | | | | |
|-------------------------|---------------|-----------|---------------|----------|---------------|-------------|------------------|
| NS 1026 | 101.27.02.009 | NS 650 05 | 5345423248 | NS 72102 | 101.14.01.047 | NS 84808 | 5361721041010000 |
| NS 10514 | 5344239003 | NS 650 05 | 101.14.11.023 | NS 82200 | 5475421257 | NS 92005 | 101.28.07.015 |
| NS 10514 | 5345423205 | NS 650 06 | 5345423248 | NS 82200 | 101.27.02.006 | NS 92207 | 5329220700 |
| NS 10514 | 5341723900300 | NS 650 06 | 101.14.11.023 | NS 82201 | 5475421257 | NS 92504 | 532642215132 |
| NS 10514 | 101.14.05.007 | NS 710 00 | 5345423247 | NS 82201 | 101.27.02.006 | NS 94100 01 | 5326422142290000 |
| NS 31900 | 96408134 | NS 710 00 | 101.27.02.010 | NS 82600 | 290130801 | NS 94200 01 | 5326422143400000 |
| NS 33700 | 96408134 | NS 721 02 | 534542324701 | NS 84807 | 5366422121120 | NS B 1028 | 558NS1028 |
| NS 52318 | 5423147 | NS 523 25 | 534542314701 | | | | |

| SCANIA | | | | | | | |
|----------|---------|-----------|---------|----------|----------|----------|---------|
| NS 30401 | 532583 | NS 524 15 | 1012085 | NS 80303 | 1308710 | NS 83727 | 1402004 |
| NS 30402 | 532583 | NS 650 05 | 621730 | NS 80303 | 005283 | NS 83727 | 1432186 |
| NS 44100 | 343795 | NS 650 06 | 621730 | NS 80303 | 365565 | NS 83727 | 1432187 |
| NS 44100 | 370710 | NS 803 01 | 308710 | NS 80303 | 365565 | NS 83727 | 1436783 |
| NS 44100 | 1303471 | NS 803 01 | 365565 | NS 81100 | 1369849 | NS 83727 | 1481301 |
| NS 44500 | 314572 | NS 803 01 | 1122696 | NS 81100 | 1402004 | NS 83727 | 1500308 |
| NS 44800 | 328655 | NS 803 01 | 1308710 | NS 81100 | 1432187 | NS 83727 | 1517966 |
| NS 44801 | 311969 | NS 803 01 | 005283 | NS 81100 | 1599007 | NS 83727 | 2993923 |
| NS 44900 | 1303471 | NS 803 01 | 365565 | NS 81400 | 1369849 | NS 83804 | 1432187 |
| NS 45000 | 1303472 | NS 803 01 | 365565 | NS 81400 | 1402004 | NS 83804 | 1481301 |
| NS 46000 | 1472739 | NS 803 02 | 308710 | NS 81400 | 1432187 | NS 82200 | 308710 |
| NS 46100 | 1472738 | NS 803 02 | 365565 | NS 81400 | 1599007 | NS 82200 | 365565 |
| NS 46100 | 1549298 | NS 803 02 | 1122696 | NS 81401 | 1369849 | NS 82201 | 308710 |
| NS 52302 | 158717 | NS 803 02 | 1308710 | NS 81401 | 1402004 | NS 82201 | 365565 |
| NS 52401 | 394328 | NS 803 02 | 005283 | NS 81401 | 1432187 | NS 84305 | 308710 |
| NS 52408 | 297807 | NS 803 02 | 365565 | NS 81401 | 1599007 | NS 84305 | 365565 |
| NS 52408 | 393101 | NS 803 02 | 365565 | NS 83711 | 21075531 | NS 84702 | 1759435 |



| SCANIA | | | | | | | |
|------------|---------|-----------|---------|------------|----------|------------|------------|
| NS 5 24 13 | 297807 | NS 803 03 | 308710 | NS 8 37 18 | 21075531 | NS 8 66 01 | 01903600 A |
| NS 5 24 13 | 3933101 | NS 803 03 | 365565 | NS 8 37 27 | 1369849 | NS 8 66 02 | 01903600 A |
| NS 5 24 14 | 394328 | NS 803 03 | 1122696 | NS 8 37 27 | 1369849 | NS 8 66 03 | 01903600 A |

| SEAT | | | | | | | |
|------------|-----------------|-----------|---------------|------------|-----------------|------------|------------------------|
| NS 4 19 01 | KDWHC09644 | NS 302 00 | EA-942000.04 | NS 3 02 01 | CA/EA942 200004 | NS 3 04 00 | 03091908 1B |
| NS 4 37 00 | 3933559 | NS 302 00 | HB942.000.30 | NS 3 02 01 | HB942.000.30 | NS 3 04 00 | 05691908 1B |
| NS 4 37 00 | 3934560 | NS 302 00 | HB-942000.30 | NS 3 02 01 | SE02.0942000A | NS 3 09 00 | 3933680 |
| NS 4 37 00 | 3935441 | NS 302 00 | SE02.0942000A | NS 3 02 01 | CA-942000.04 | NS 3 09 00 | 3940980 |
| NS 4 37 00 | 3935442 | NS 302 00 | SE-020942000A | NS 3 02 01 | EA-942000.04 | NS 3 09 00 | 4459907 |
| NS 3 02 00 | 5927407 | NS 302 01 | 3933681 | NS 3 02 01 | HB-942000.30 | NS 3 09 00 | FA942000 0001/02/03/04 |
| NS 3 02 00 | CA/EA94 2200004 | NS 302 01 | 5927407 | NS 3 02 01 | SE-020942000A | NS 3 09 00 | SE02 2942000A |
| NS 3 02 00 | CA-9420 00.04 | | | | | | |

| STEYR | | | | | | | |
|------------|--------------|-----------|--------------|------------|----------------|------------|--------------|
| NS 1 01 12 | 52.58.13 | NS 523 02 | 9911471 0001 | NS 5 23 24 | 38093601 55 | NS 3 04 02 | 40709001 2 |
| NS 1 03 31 | 0520058 0004 | NS 134 01 | 1925800 39 | NS 5 23 24 | 79100710 028 | NS 3 04 02 | 61000090 003 |
| NS 1 05 11 | 52.58.39 | NS 134 01 | 3975800 03 | NS 6 03 03 | 52.35.21 | NS 3 04 02 | 609F070133 |
| NS 1 24 00 | 9200580 012 | NS 134 02 | 1925800 39 | NS 6 50 05 | 536 0801 80000 | NS 4 01 00 | 1,33701E+11 |
| NS 1 24 00 | 27/950-110 | NS 134 02 | 3975800 03 | NS 6 50 05 | 680 58 00 89 | NS 6 50 06 | 680 58 00 89 |
| NS 1 24 02 | 9200580 012 | NS 191 00 | 1925839 | NS 2 04 01 | 612.09.0006 | NS 8 03 01 | 050.55.10 |
| NS 1 24 02 | 27/950-110 | NS 191 00 | 5,931E+12 | NS 2 04 01 | X8300300 53000 | NS 8 03 02 | 52005500 08 |
| NS 1 34 00 | 192.58.39 | NS 191 00 | 052.58.03 | NS 3 04 01 | 61000090 003 | NS 8 03 02 | 050.55.10 |
| NS 4 06 01 | 6000770 242 | NS 204 00 | 612.09.0006 | NS 3 04 01 | 609F070133 | NS 8 03 03 | 52005500 10 |
| NS 4 16 01 | 52.71.01 | NS 449 00 | 7910071 0068 | NS 4 50 00 | 70230401 200 | | |

| TEMSA | | | | | | | |
|------------|-------------|-----------|-----------------|------------|----------------|------------|---------------|
| NS 5 23 24 | 7803603 57 | NS 710 00 | NK267208 Y | NS 8 43 05 | CG160 404 Y | NS 8 44 22 | TB125427 Y |
| NS 1 47 02 | CG254 500 Y | NS 836 00 | 0005B 160116 Y | NS 8 44 01 | CG160 115 Y | NS 8 56 00 | CG160 115 Y |
| NS 4 25 01 | FE80 7101 Y | NS 836 00 | SB160116 Y | NS 8 44 01 | TB125427 Y | NS 8 56 00 | TB125427 Y |
| NS 4 29 06 | FE80 7201 Y | NS 650 06 | 536 0801 8000 0 | NS 8 44 04 | CG160 115 Y | NS 8 58 00 | CG160 115 Y |
| NS 5 23 30 | TY153163 | NS 836 01 | 000CG 1601 16 Y | NS 8 44 04 | TB125427 Y | NS 8 58 00 | TB125427 Y |
| NS 5 23 31 | TY153164 | NS 839 05 | CG160 404 Y | NS 8 44 22 | CG160 115 Y | NS 9 40 00 | 150218-C5P-00 |
| NS 5 23 32 | TY153165 | NS 803 03 | 050.55.10 | NS 9 76 01 | 000CM 150185 Y | | |

| TOYOTA | | | | | | | |
|------------|-------------|-----------|----------------|------------|----------------|------------|----------------|
| NS 2 18 00 | 83420-12010 | NS 318 00 | 83530-10010 | NS 3 37 00 | 83530-14010.20 | NS 3 37 00 | 83530-30041.43 |
| NS 2 18 00 | 83420-16010 | NS 318 00 | 83530-10020/ | NS 3 37 00 | 83530-14030.40 | NS 3 37 00 | 83530-30080 |
| NS 2 18 00 | 83420-20010 | NS 337 00 | 83530-10010.20 | NS 3 37 00 | 83530-14050 | NS 3 37 00 | 83530-60040 |
| NS 2 18 00 | 83420-20011 | NS 337 00 | 83530-12010.20 | NS 3 37 00 | 83530-28030 | NS 3 37 00 | 85530-02030 |
| NS 2 18 00 | 83420-20020 | NS 337 00 | 83530-12040 | NS 3 37 00 | 83530-30030 | NS 4 35 00 | 84340-30010 |
| NS 3 01 00 | 835330 | | | | | | |

| TÜMÖSAN | | | | | | | |
|------------|---------------|-----------|--------------------|------------|---------------|------------|---------------|
| NS 1 07 00 | 7252413 | NS 302 00 | 4999853 | NS 4 09 01 | 7252563 | NS 5 23 04 | 000A-72523 80 |
| NS 1 07 01 | 7252413 | NS 302 00 | 7253639 | NS 4 09 01 | 7257720 | NS 6 50 08 | 0-72 58760 |
| NS 1 07 02 | 000A-72524 13 | NS 302 00 | 000A-72536 39 | NS 4 09 01 | 000A-72577 20 | NS 8 15 00 | 0-71 52791 |
| NS 1 09 00 | 7250205 | NS 302 01 | 4999853 | NS 4 30 03 | 7250624 | NS 8 26 01 | 5105346 |
| NS 1 91 00 | 7250636 | NS 302 01 | 7252563 | NS 4 30 03 | 000A-72506 24 | NS 8 26 01 | 7250937 |
| NS 2 05 00 | 7253656 | NS 212 00 | 7253656 | NS 5 23 04 | 7252380 | NS 8 26 01 | 000A-72509 37 |
| NS 2 05 00 | 000A-72536 56 | NS 205 00 | 2.7099.360.100.0/1 | | | | |

| VALTRA | | | | | | | |
|------------|-----------|-----------|----------|------------|----------|------------|----------|
| NS 1 05 39 | 32553200 | NS 103 17 | 816450 | NS 1 03 17 | 32553200 | NS 1 03 28 | 816450 |
| NS 5 24 23 | DV016 011 | NS 103 00 | 32553200 | NS 1 03 25 | 816450 | NS 1 03 28 | 32553200 |
| NS 1 03 00 | 816450 | NS 103 25 | 32553200 | NS 4 09 02 | 684690 | | |

| VOLKSWAGEN | | | | | | | |
|------------|-------------|-----------|-----------------|------------|------------------|------------|-------------|
| NS 3 02 00 | 00A919081 | NS 304 02 | 0219190 81A/B/C | NS 3 04 00 | 02191908 1C | NS 3 04 02 | 21919081 |
| NS 3 02 01 | 00A919081 | NS 304 02 | 0219190 81C | NS 3 04 00 | 02891908 1H | NS 3 04 02 | 28919081 |
| NS 3 04 01 | 2191908 1 | NS 304 02 | 0569190 81C | NS 3 04 01 | 02109190 21A/B/C | NS 3 04 02 | 59919081 |
| NS 3 04 01 | 2891908 1 | NS 304 01 | 0219190 81B | NS 3 04 02 | 06191908 1B | NS 3 04 02 | 11191908 1 |
| NS 3 04 01 | 5991908 1 | NS 304 01 | 0619190 81B | NS 3 04 02 | 11191908 1A | NS 3 04 02 | 11391908 1 |
| NS 3 04 01 | 1119190 81 | NS 304 01 | 1119190 81A | NS 3 04 02 | 31191908 1A | NS 3 04 02 | 26919081 1 |
| NS 3 04 01 | 1139190 81 | NS 304 01 | 3119190 81A | NS 3 04 01 | 02891908 1D | NS 3 37 00 | J8353014030 |
| NS 3 04 01 | 0219190 81A | NS 419 01 | KDWHC09644 | NS 3 04 01 | 05691908 1C | NS 5 24 15 | 2TA94 5517 |



| VOLVO | | | | | | | |
|----------|-----------|-----------|-----------|----------|----------|----------|----------|
| NS 13000 | 2173860 | NS 523 03 | 20528490 | NS 80303 | 308069 | NS 84401 | 1189577 |
| NS 30402 | 1257137 | NS 523 17 | 1566385 | NS 80303 | 1580244 | NS 84401 | 3198271 |
| NS 30402 | 12571378 | NS 523 24 | 238460 | NS 80303 | 1586037 | NS 84401 | 8152630 |
| NS 80400 | 8158693 | NS 523 24 | 241401 | NS 80303 | 1599007 | NS 84401 | 8158693 |
| NS 82200 | 308069 | NS 523 24 | 4786037 | NS 80303 | 9520400 | NS 84401 | 20392751 |
| NS 82201 | 308069 | NS 523 24 | 11704264 | NS 80303 | 20392750 | NS 84401 | 8152630 |
| NS 30100 | 1218684 | NS 524 01 | 1132028 | NS 81100 | 1186577 | NS 84404 | 1189577 |
| NS 30100 | 1218690 | NS 524 08 | 6228623 | NS 81100 | 1189577 | NS 84404 | 3198271 |
| NS 30100 | 1266085 | NS 524 13 | 6228623 | NS 81100 | 3198271 | NS 84404 | 8152630 |
| NS 30100 | 1324750 | NS 524 13 | 6628623 | NS 81100 | 8152630 | NS 84404 | 8158693 |
| NS 30100 | 1266085-8 | NS 524 14 | 1132028 | NS 81100 | 8158693 | NS 84404 | 20392751 |
| NS 30100 | 1324750-7 | NS 524 15 | 40020 | NS 81100 | 20392749 | NS 84404 | 8152630 |
| NS 30100 | 1606877-7 | NS 524 15 | 11016535 | NS 81100 | 20392751 | NS 84422 | 1189577 |
| NS 30400 | 1257137 | NS 524 15 | 102140600 | NS 81100 | 20392751 | NS 84422 | 3198271 |
| NS 30400 | 1257137-8 | NS 551 01 | 4803620 | NS 81400 | 1186557 | NS 84422 | 8152630 |
| NS 30900 | 31007559 | NS 650 05 | 3987034 | NS 81400 | 1186577 | NS 84422 | 8158693 |
| NS 30900 | 3100759-4 | NS 650 05 | 240315 | NS 81400 | 1189577 | NS 84422 | 20392751 |
| NS 30900 | 334004-39 | NS 650 06 | 3987034 | NS 81400 | 3198271 | NS 84422 | 8152630 |
| NS 33000 | 339500 | NS 650 06 | 240315 | NS 81400 | 8152630 | NS 84702 | 20926021 |
| NS 33000 | 672910 | NS 652 00 | 1111077 | NS 81400 | 8158693 | NS 84702 | 20926022 |
| NS 33000 | 1218684 | NS 652 00 | 1263488 | NS 81400 | 20392749 | NS 84702 | 21075528 |
| NS 33000 | 1266085 | NS 803 01 | 308069 | NS 81400 | 20392751 | NS 85600 | 1189577 |
| NS 33000 | 1324750-7 | NS 803 01 | 1580244 | NS 81401 | 1186557 | NS 85600 | 3198271 |
| NS 33000 | 1606877-7 | NS 803 01 | 1586037 | NS 81401 | 1186577 | NS 85600 | 8152630 |
| NS 40902 | 19202000 | NS 803 01 | 1599007 | NS 81401 | 1189577 | NS 85600 | 8158693 |
| NS 46000 | 3197871 | NS 803 01 | 9520400 | NS 81401 | 3198271 | NS 85600 | 20392751 |
| NS 46100 | 1078493 | NS 803 01 | 20392750 | NS 81401 | 6795590 | NS 85600 | 8152630 |
| NS 46100 | 3197870 | NS 803 02 | 308069 | NS 81401 | 8152630 | NS 85800 | 1189577 |
| NS 52302 | 240112 | NS 803 02 | 1580244 | NS 81401 | 8158693 | NS 85800 | 3198271 |
| NS 52302 | 241374 | NS 803 02 | 1586037 | NS 81401 | 20392749 | NS 85800 | 8152630 |
| NS 52302 | 1571540 | NS 803 02 | 1599007 | NS 81401 | 20392751 | NS 85800 | 8158693 |
| NS 52302 | 3092454 | NS 803 02 | 9520400 | NS 83905 | 2804116 | NS 85800 | 20392751 |
| NS 52302 | 15715402 | NS 803 02 | 20392750 | NS 84305 | 308069 | NS 85800 | 8152630 |

| WABCO | | | | | | | |
|----------|------------|-----------|------------|----------|------------|----------|------------|
| NS 52300 | 4410140190 | NS 523 22 | 3B71 203 | NS 52408 | 4110140140 | NS 52413 | 4110140150 |
| NS 52303 | 4410140010 | NS 524 00 | 4410141020 | NS 52409 | 4410141010 | NS 52414 | 4410140040 |
| NS 52317 | 4410140050 | NS 524 01 | 4410140040 | NS 52412 | 4410140120 | NS 52415 | 4410140250 |
| NS 52322 | 4410140400 | | | | | | |

| ZF | | | | | | | |
|----------|------------|-----------|-----------|----------|------------|----------|-----------|
| NS 44100 | 0501311818 | NS 442 00 | 501207847 | NS 44500 | 501305308 | NS 45000 | 501311607 |
| NS 44100 | 0501313916 | NS 442 00 | 501306427 | NS 44501 | 0501311809 | NS 45000 | 501311807 |
| NS 44200 | 501203994 | NS 442 00 | 501311807 | NS 45000 | 501203944 | NS 46000 | 501216474 |

KONTAKLAR İÇİN KISALTMA VE KODLAMA AÇIKLAMALARI

EXPLANATIONS OF ABBREVIATIONS AND CODING FOR STARTERS & SWITCHES

| Kısaltma - Kodlama Abbreviation - Coding | TÜRKÇE | ENGLISH |
|---|--|--|
| FEED | ANA CEREYAN - BESLEME | FEED |
| AUX | YARDIMCI | AUXILIARY |
| HTR | ISITMA | HEATER |
| STR | MARŞ | STARTER |
| START | MARŞ | STARTER |
| IGN | KONTAK | IGNITION |
| RAD | RADYO | RADIO |
| DIP | KISA FAR | DIPPED LIGHTS |
| ACC | AKSESUAR AYDINLATMA | ACCESORIES |
| ON | AÇIK | ON |
| OFF | KÂPALI | OFF |
|  | GERİ YAY HAREKETİ | SPRING RETURNED |
| TAIL | ARKA STOPLAR | TAIL LIGHTS |
| SIDE | YAN SINYALLER | SIDE LIGHTS |
| S&T | ARKA STOP VE YAN SINYALLER | SIDE AND TAIL LIGHTS |
| PANEL | GÖSTERGE PANELİ AYDINLATMASI | PANEL LIGHTS |
|  | KORNA İÇİN TOPUZU İTİNİZ | PUSH KNOB FOR HORN |
| FSO | YAKIT KESME | FUEL SHUT OFF |
| PARK | PARK LAMBALARI | DIPPED LIGHTS |
| HORN | KORNA | HORN |
| MEAN BEAM | UZUN FARLAR | MEAN BEAM |
| STP | STOP | STOP |
| T | ANA CEREYAN - BESLEME | FEED |
| AIR | HAVALANDIRMA | AIRATION |
| LOW | 1.KADEME ISITMA | LOW HEAT |
| HIGH | 2.KADEME ISITMA | HIGH HEAT |
| FRONT RIGHT | ÖN SAĞ SİNYAL LAMBASI | FRONT RIGHT SIGNAL LIGHT |
| FRONT LEFT | ÖN SOL SİNYAL LAMBASI | FRONT LEFT SIGNAL LIGHT |
| BACK RIGHT | ARKA SAĞ SİNYAL LAMBASI | BACK RIGHT SIGNAL LIGHT |
| BACK LEFT | ARKA SOL SİNYAL LAMBASI | BACK LEFT SIGNAL LIGHT |
|  | KONTAK POZİSYON SAYISI VE ÇEVİRME YÖNÜ | NUMBER OF SWITCH POSITIONS AND DIRECTION OF ROTATION |
| 1,2,3,4,5,6..... | TERMINAL NUMARALARI | TERMINAL NUMBERS |
| 30 | ANA CEREYAN - BESLEME | FEED |
| 15/54 | YARDIMCI - ISITMA | AUXILIARY - HEATER |
| 50 | MARŞ | STARTER |
| 50 | STOP | STOP |
| 57/58 | ANA CEREYAN - BESLEME | FEED |
| 15 | BESLEME - KISA FAR - KONTAKTA | FEED - DIPPED LIGHT - STAND BY |
| 50a | ISITMA | HEATER |
| 56a | KISA FARLAR | SHORT BEAM |
| 56b | UZUN FARLAR | LONG BEAM |
| 56 | UZUN FARLAR | MEAN BEAM |
| 58 | PARK LAMBASI - STOP LAMBASI | PARK LIGHTS - STOP LIGHTS |
| 17 | KONTAK | IGNITION |
| 19 | YARDIMCI | AUXILIARY |

NOT: BAZI İMALATÇI ADLARI REFERANS AMAÇLI VERİLMİŞTİR VE ÜRÜNLERİMİZİN TAMAMININ BU MARKALARDA ORJİNAL PARÇA OLARAK KULLANILDIĞI ANLAMINA GELMEZ.

NOTE: SOME MANUFACTURE NAMES ARE REFERENCE PURPOSE ONLY AND ARE NOT INTENDED TO SUGGEST THAT ALL OF OUR PARTS ARE USED ORIGINAL EQUIPMENT.